

# **BOLENS HUSKYS**

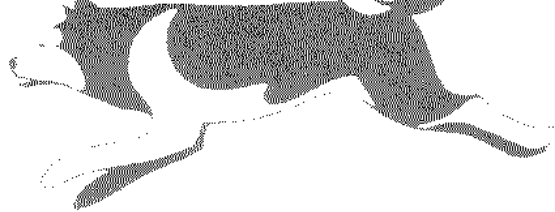

**1477  
HYDROSTATIC**



**OWNER OPERATION &  
MAINTENANCE MANUAL**

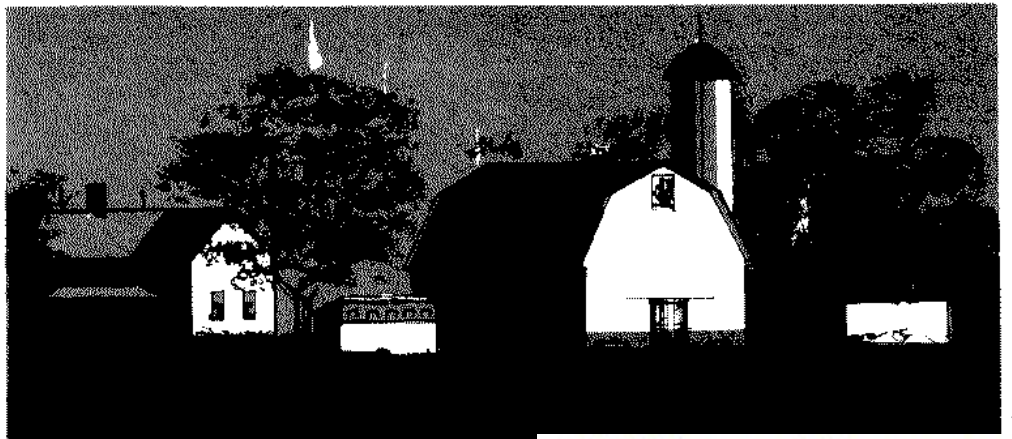
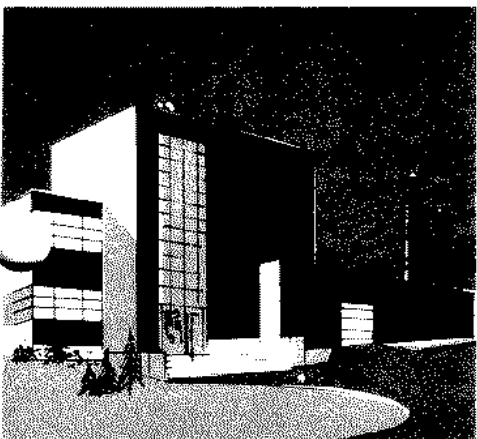

## CONGRATULATIONS

On your purchase of a Bolens Husky, one of the finest available. Please take a few moments to review this manual to familiarize yourself with the unit, its features and its operation. To obtain maximum performance and life, carefully follow all instructions and maintenance recommendations. This manual serves this purpose with easy-to-follow instructions, illustrations and charts.



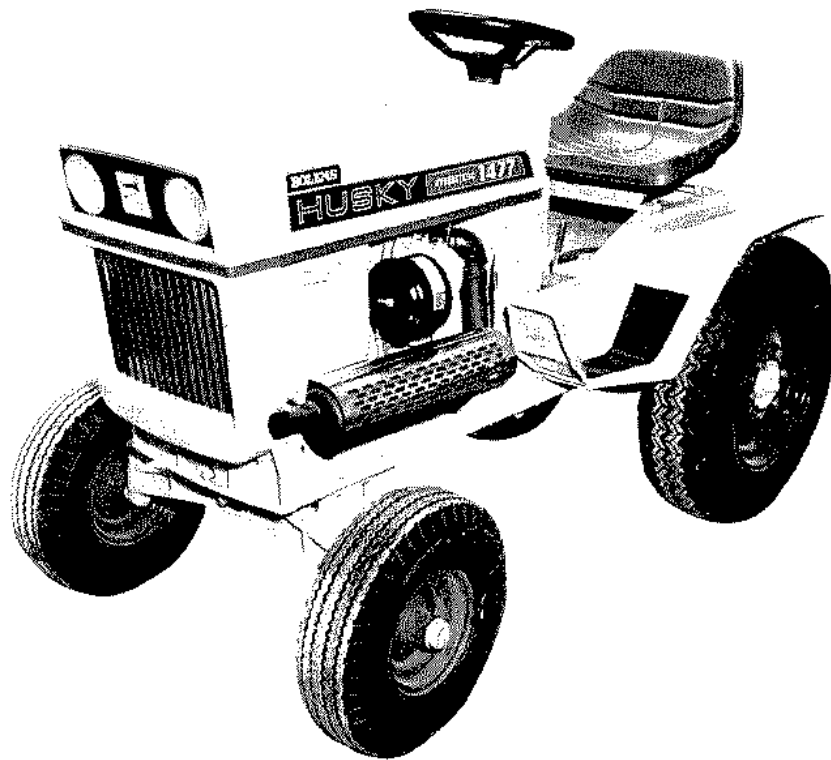

# 1477 HYDROSTATIC

## TABLE OF CONTENTS

	Page		Page
General Safety Precautions .....	2	Preventive Maintenance .....	9
Engine Cautions .....	3	Adjustments .....	11
Serial Number .....	4	Lubrication .....	14
Specifications .....	4	Lubrication Chart .....	14
Controls .....	5	Minor Trouble Shooting Guide .....	16
Pre-Operational Checks .....	6	Wiring Diagram .....	16
Break-In Period .....	6	Optional Equipment .....	17
Starting the Engine .....	6	Power Take-Off (P.T.O.) .....	18
Stopping the Engine .....	7	Wheel Weight Kit .....	18
Operation .....	7	Maintenance Guide .....	19
Run-In Period .....	9	Storing Your Husky Tractor .....	19

## GENERAL SAFETY PRECAUTIONS

Preventing accidents is the responsibility of every equipment operator. The following general safety precautions *must* be fully understood and followed by every operator of this tractor and its attachments. Review them frequently and **NEVER TAKE CHANCES. BE CAREFUL BEFORE, DURING AND RIGHT AFTER USE OF ANY POWERED EQUIPMENT. ACCIDENTS CAN BE PREVENTED.**

1. Mount vehicle, place transmission shift lever in **PARK** and put P.T.O. lever in **OFF** position prior to starting engine. Engine will not start unless transmission lever is in **PARK** or **NEUTRAL** and P.T.O. lever is in **OFF** position.
2. Do not mount or leave vehicle while it is in motion or in actual operation, nor leave vehicle unattended while engine is running. Injury to the operator or a tractor run-away could occur.
3. Always shut off engine, remove key, and place transmission lever in **PARK** whenever vehicle is to be left unattended. Lower all attachments to the ground and put P.T.O. lever in **OFF** position when leaving the unit unattended, to prevent injury to bystanders.
4. Attachments must be lowered to the ground when storing tractor, to prevent the attachment from being dropped accidentally and causing injury. Put P.T.O. lever in **OFF** position.
5. Do not tow vehicle over 5 miles per hour. Damage to the vehicle could occur.
6. When towing or moving the vehicle, place transmission lever in **NEUTRAL**. Do not tow with attachments on vehicle. Damage to the transmission or attachment could occur.
7. Do not carry passengers. The passengers could fall off vehicle receiving injuries.
8. Keep hands clear of transmission cooling fan and all moving parts. These could cause serious injury when tractor is running.
9. Do not start or operate vehicle in an inside area, unless it is adequately ventilated. Engine exhaust contains carbon monoxide fumes, which are very poisonous.
10. Keep tractor and attachments free of excess grease and oil. The unit will operate cooler, be easier to maintain, and safer to operate.
11. Engine must be stopped, and P.T.O. disengaged when cleaning, servicing, adjusting, repairing, or installing attachments on tractor. This is necessary to avoid possible injury from moving parts.
12. Always disconnect ground (-) battery cable from battery before doing any work on the electrical system. Reconnect it **LAST** when work is done. This is to prevent accidental burns and shorting of electrical system.
13. Study your manual. Know your tractor before operating it. Take time to operate the unit in the safest manner.
14. Always follow manufacturer's operational suggestions.
15. Do not allow children to operate vehicle at any time. The average child is not capable of coping with the intricacies of operating a power tool.
16. Do not fill gasoline tank when engine is running or hot. Add gas (using funnel) only outdoors and when engine is cool. **KEEP SMOKERS AND FLAMES AWAY FROM UNIT WHILE FUELING.** This will help eliminate the possibility of fire and/or explosion from spilled gasoline or fumes.
17. Refuel tractor from the **Left** side, the side which the fuel tank is on. This is safer and more convenient than reaching over tractor with fuel can.
18. Do not allow adults to operate vehicle without proper instructions including all safety instructions. In doing so, you will be sure they know how to operate unit properly and also are aware of all the safety precautions.
19. Store fuel in approved container out of reach of children. Do not store fuel in the house. Gasoline is highly flammable and the fumes highly explosive.
20. Never operate tractor with mower, snow caster, or any other attachment having moving parts, when any child or another person is in travel path or discharge area. Children must not be allowed in or near working areas when equipment is being used. Items or objects such as wire, stones, small toys, and etc. can be ejected at high velocity out of the discharge chute.
21. Always look back to be certain no one is in the way before using reverse. This will avoid the possibility of running over any bystanders or pets who might be in the area in back of the vehicle.
22. Study all attachment manuals thoroughly before using attachments with tractor, to be aware of both the tractor and attachment capabilities when used as a unit, also the safest manner in which to operate them.
23. Before starting unit check to be sure *all* guards and safety devices are in place and in working condition. This will help assure you against possible injury.
24. Do not drive this unit on a public thoroughfare at any time. The operator is risking injury from passing vehicles. Most local ordinances prohibit operating a unit such as this on a public thoroughfare.
25. Do not drive too close to a creek or ditch; also be alert for holes and other hazards. If you would drive into any of the above you could lose control of the unit.
26. Be careful on slopes, reduce speed and avoid sharp turns to prevent tipping or loss of control.

## GENERAL SAFETY PRECAUTIONS (Cont.)

27. Never wear loose clothing when operating unit. Loose clothing can get caught in moving parts and cause severe injuries.

THE ENGINE WILL START ONLY WHEN P.T.O. CONTROL LEVER IS IN "OFF" POSITION AND TRANSMISSION LEVER IS IN "PARK" OR "NEUTRAL" POSITION.

## ENGINE CAUTIONS

Do not run engine at full throttle to hurry warm-up after starting, but idle it a few minutes; this will give the oil a chance to circulate through the engine.

Do not operate the engine at any time with cooling shroud removed; this will prevent proper cooling of engine.

Check and service air cleaner every 10 hours or oftener under severe dust and dirt conditions. A dirty or plugged air-cleaner can lead to loss of power and consequential damage to the engine.

After every 8 hours of operation check oil level. For correct grade of oil and proper oil level, see engine manufacturer's manual. If the oil in the crankcase is allowed to remain below the required level damage to the engine bearings, cylinder walls, pistons and other moving parts could result from overheating.

After every 50 hours of operation, or oftener under severe conditions, the engine crankcase should be drained and

refilled with fresh oil. See engine manual for proper specifications and quantity of oil.

The gasoline strainer should be inspected frequently. If dirt and water are present in the bowl, the bowl and screen should be removed and cleaned. When reassembling strainer be sure gasket is in good condition; use a new gasket if necessary.

When stopping engine do not stop abruptly, but idle the engine at low RPM for 3 to 5 minutes. This will allow temperatures to normalize more rapidly preventing overheating.

### SPARK PLUG

The spark plug should be cleaned inside and out and regapped every 100 hours or once each year, whichever occurs first. Check engine manual for correct gap setting. Replace plug whenever necessary. See engine manual for correct plug specifications.

## TO THE OWNER

This is an operational and general maintenance manual only and does not cover major repair. All major repair work must be performed by an authorized BOLENS DEALER or the factory warranty is void. Bolens equipment is carefully engineered to give good performance if properly operated and maintained. Keep your equipment clean and lubricate it as prescribed in this manual. Frequently inspect your unit and perform any upkeep maintenance necessary. Check for loose or missing hardware, needed oil or lubrication, damaged parts, etc.

Your dealer is obligated by the factory to completely assemble and service new equipment prior to first delivery, and thoroughly explain and demonstrate its operation. He will repair or replace any parts which fail due to defective material and/or workmanship during the warranty period, and also provide future repair service and supply genuine factory repair parts.

**IN EVENT OF ANY PROBLEM OR PARTS REQUIRED ALWAYS CONTACT YOUR DEALER. DO NOT RETURN PARTS TO THE FACTORY. WE REQUIRE PRIOR FACTORY APPROVAL ON RETURNS, AND APPROVALS ARE ISSUED ONLY TO BOLENS DEALERS OR DISTRIBUTORS.**

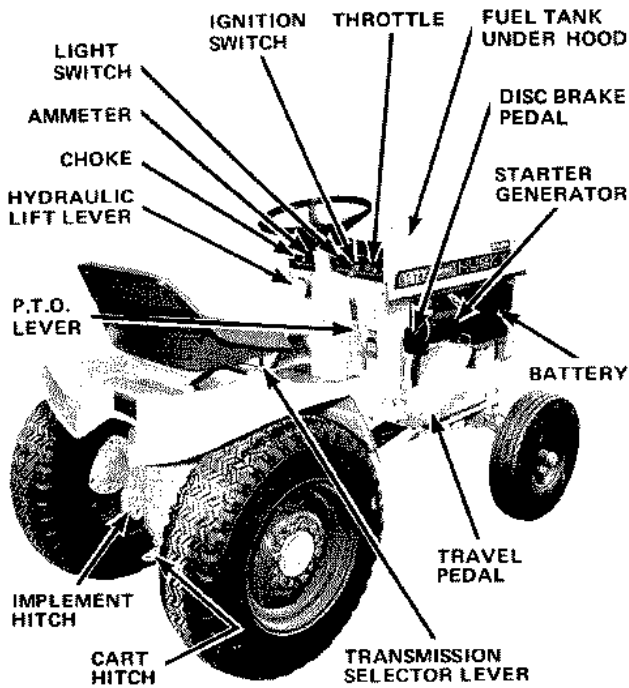

Figure 1

### SERIAL NUMBER

To ensure prompt service when repairs or adjustments are required, your Bolens Dealer must have the following information:

1. Model number of unit.
2. Serial number of unit.
3. Model number of engine.
4. Serial and Spec. number of engine.

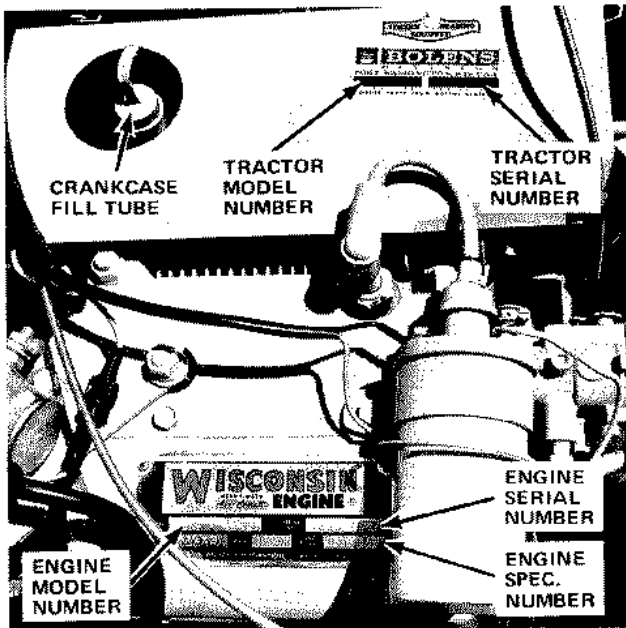

Figure 2

Your Bolens dealer has available a master Parts List for your unit. He can identify any parts you may require and furnish genuine factory replacements.

When ordering engine component parts, consult the Engine Manufacturer's Manual.

For your own personal reference, fill in the spaces provided below.

Model Number of Unit \_\_\_\_\_

Serial Number of Unit \_\_\_\_\_

Engine Model Number \_\_\_\_\_

Engine Serial Number \_\_\_\_\_

Engine Spec. Number \_\_\_\_\_

### SPECIFICATIONS

(Specifications subject to change without notice.)

### NOTE

*BOLENS RESERVES THE RIGHT TO MAKE CHANGES OR IMPROVEMENTS TO ITS PRODUCTS WITHOUT OBLIGATION TO INSTALL SAME ON PRODUCTS PREVIOUSLY MANUFACTURED.*

Engine	33.1 cu. inch Wisconsin
Type	4 cycle, single cylinder, air cooled
Fuel capacity	5.3 gallons
Engine oil capacity	2 quarts
Transmission oil capacity	10 quarts
Air cleaner	Dry type
Drive	Hydrostatic transmission
Speed. Infinitely variable	Forward: approx. 0-8 mph Reverse: approx. 0-4 mph
Power to attachments	Triple belt drive (P.T.O.), with universal joints and splined shaft.
Tires	Front: 5.70/5.00-8 (See Option Page 16) Rear: See optional equipment section, page 16.
Height	45 inches
Width	38 inches
Length	72 inches
Wheelbase	49 inches
Turning radius	54 inches
Ground clearance	8-1/2 inches
Shipping weight	975 lbs.
Standard equipment	P.T.O., splined shaft to drive front, center or rear attachments, hydraulic lift system, electric starting, head lights and tail lights, full fenders, adjustable all angle seat — spring suspension with foam padded adjustable seat (easily removable for weather protection), 45 amp battery, selector lever for

drive-neutral-park. Interlock switches to prevent tractor from being started with P.T.O. lever in DRIVE position. Tapered roller bearing front wheels and replaceable spindle bushings, automotive type muffler, compression release for easy starting, solid state ignition, three-unit regulator (automotive type), ammeter, extra-heavy channel frame, tilting hood for access to engine.

Location of tractor model and serial number ..... Top left side of heat shield  
 Location of engine model and serial number ..... Front of engine cowling

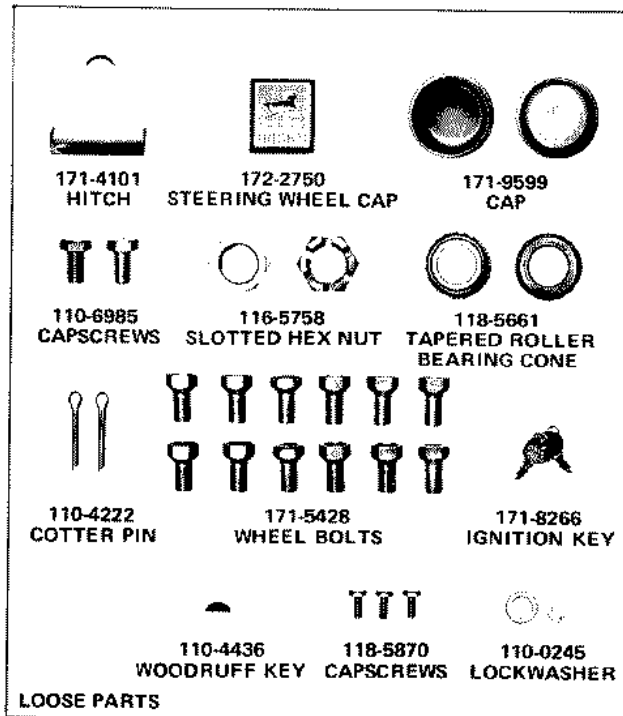

Figure 3

## CONTROLS

Before operating the tractor, the operator should become familiar with the function and location of each control to ensure proper and efficient operation.

The following listed numbers and accompanying information correspond to those numbers assigned to the controls indicated in Figure 4.

1. Choke. Pull choke knob out to operate choke.
2. Ammeter. Indicates rate of charge or discharge to or from battery.
3. Light Switch. Pull light switch knob out to turn on lights...push in to turn lights off.

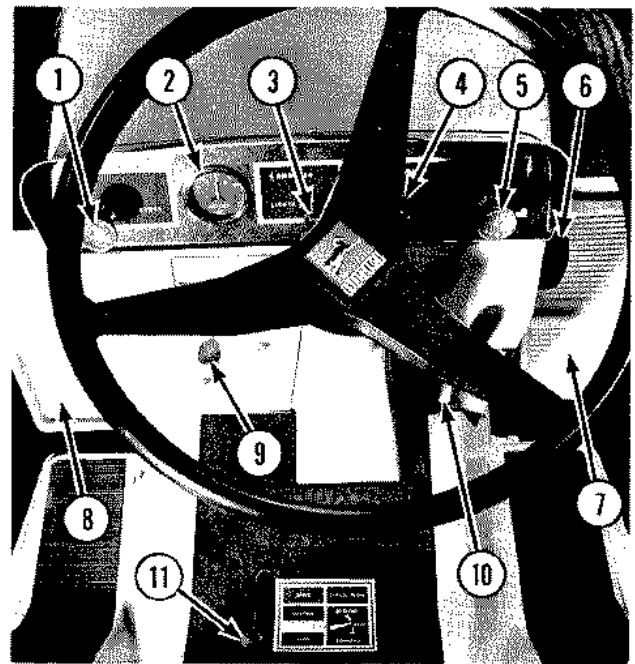

Figure 4

### NOTE

*IGNITION-STARTER SWITCH (4) MUST BE ON TO TURN ON HEAD AND TAIL LIGHTS.*

4. Ignition-Starter Switch. Turn ignition key to the right to start engine. Release when engine starts.

### NOTE

*DO NOT ACTUATE STARTER MORE THAN 30 SECONDS AT ONE TIME. LET STARTER COOL FOR TWO MINUTES.*

5. Throttle. Pull throttle knob out one-half way for starting. more or less throttle may be required due to grade of fuel and temperature variations. Allow engine to warm up, then adjust throttle to full engine RPM while operating.
6. Foot Brake. Use when vehicle is being towed or in neutral; when moving transmission selector lever (12) from NEUTRAL or PARK position to DRIVE position.
7. Travel Pedal. Depress pedal with toe of foot for forward motion. Depress with heel of foot for reverse motion. Provides instant braking (center position) and speed regulation. (See Figure 6.)
8. Foot Rest.
9. Hydraulic Lift Lever. Pull lever up to raise and push lever down to lower attachments. Push lift lever all the way down into lock for FLOAT position.
10. Power Take-Off (P.T.O.) Lever. Engages and disengages power to attached implements. Lever positions indicated on decal.

11. Transmission Lever. Place transmission selector lever in . . .

NEUTRAL for towing. Do not tow over 5 mph.

DRIVE for infinitely variable speeds from approximately 0-8 mph forward to 0-4 mph in reverse.

PARK for starting and when tractor is at rest.

### CAUTION

*DO NOT PLACE TRANSMISSION LEVER INTO PARK POSITION WHILE TRACTOR IS IN MOTION. SHIFTING INTO PARK WHILE TRACTOR IS IN MOTION WILL RESULT IN SERIOUS DAMAGE TO THE TRANSMISSION.*

## PRE-OPERATIONAL CHECKS

The operator should become familiar with the following pre-operational check list prior to starting or operating the HUSKY.

1. Thoroughly clean area around crankcase oil dipstick, and check for proper level of engine oil. See Engine Manufacturer's Manual.

2. Check battery for proper electrolyte level, should be up to triangle.

3. Check gasoline tank for sufficient gas supply.

It is most convenient to refill fuel tank from the Left hand side.

4. Check that air cleaner is free of debris. Check and clean regularly. Replace if necessary.

5. Visually check for loose or missing nuts, screws, and damaged parts. Replace and tighten before starting engine.

6. Check for even tire inflation. TIRE INFLATION SHOULD NOT BE LESS THAN 8 LBS. NOR MORE THAN 12.

7. Thoroughly clean area around hydrostatic transmission fill plug area, and check for proper level of transmission fluid. Check that transmission lever is in PARK. Start engine and allow it to idle while checking transmission fluid level.

8. Do not allow ignition switch to remain in the ON position when engine is not running. Remove key.

9. Check fuel petcock to be sure it is fully open. See Figure 5 for location.

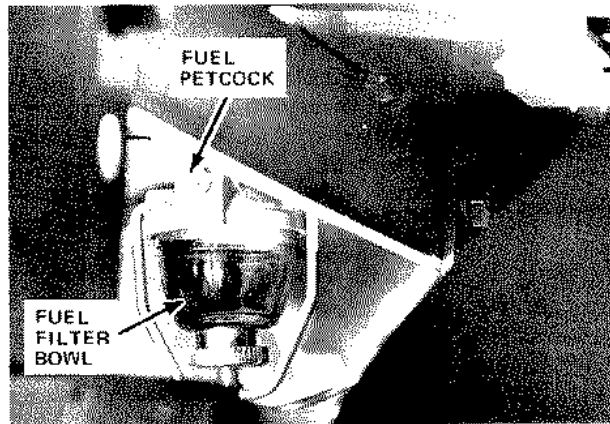

Figure 5

## BREAK-IN PERIOD

As with a new car, your new HUSKY Tractor should receive special attention. During the first few hours of operation, it is best to vary the engine speed (see inside front cover of engine manual)...avoid full-throttle driving... and avoid quick starts and stops until you have become well acquainted with your tractor.

## IMPORTANT

*THE TRACTOR IS SHIPPED FROM THE FACTORY WITH OIL IN THE ENGINE CRANKCASE. CHECK THE CRANKCASE AND THE HYDROSTATIC TRANSMISSION OIL RESERVOIR FOR PROPER OIL LEVEL BEFORE ATTEMPTING TO START YOUR UNIT. BECOME FAMILIAR WITH THE LOCATION OF EACH CONTROL. THIS TRACTOR IS EQUIPPED WITH INTERLOCK SWITCHES. THE ENGINE WILL START ONLY WHEN P.T.O. CONTROL LEVER IS IN "OFF" POSITION AND TRANSMISSION LEVER IS IN "PARK" OR "NEUTRAL" POSITION.*

Both the tractor and engine have been fully tested by the factory and your dealer to assure your complete satisfaction. Keep this manual available at all times, read it carefully; if you have any questions that are not answered in the manual, consult your Bolens dealer.

## STARTING THE ENGINE

### ELECTRIC STARTING

1. The engine will only start when P.T.O. control lever is in "OFF" position and transmission lever is in "PARK" or "NEUTRAL" position.

2. Pull out choke. Experience will indicate need for more or less choking due to temperature variations, grade of fuel, engine heat, etc.

3. Pull out throttle one-half way. More or less throttle may be required due to grade of fuel and temperature variations.



4. Turn ignition key to the right to start engine. Release key when engine starts.

5. Allow engine to warm up. Move choke slowly forward; pull out throttle and lock at *full speed* while operating.

6. To stop the engine, bring engine back to idle, place transmission lever in "PARK" and P.T.O. lever in "OFF" position and turn ignition switch off. Remove the ignition key when the tractor is not in use, or left unattended. If engine has been working hard let it idle several minutes before shutting it off. This will allow engine temperatures to normalize more rapidly preventing overheating.

#### EMERGENCY STARTING

In case of an electrical failure, proceed as follows: (See first paragraph under electric starting.)

1. Recharge or replace battery.
2. 12 Volt Jumper cables may be used.

#### NOTE

*IF JUMPER CABLES ARE USED, CABLES MUST BE CONNECTED, POSITIVE (+) TO POSITIVE (+) AND NEGATIVE (-) TO NEGATIVE (-).*

3. After engine has started, allow it to warm up. Move choke knob slowly forward, pull out throttle and lock at full speed.

4. Remove tractor battery and have it fully charged as soon as possible.

5. After the battery is fully recharged and has been checked, reinstall it in the tractor, being careful to connect ground cable *last*.

6. Check generator belt for proper tension. Belt should depress 1/4 inch between pulleys with normal thumb pressure as shown in Figure 6. Should adjustment be required, shut engine off, loosen the 2 lower generator mounting screws "B" and generator adjusting screw "A". Pivot generator outward from engine until proper tension is obtained.

#### NOTE

*NEVER PRY OUT GENERATOR WITH A LONG HEAVY BAR OR TOOL AS THIS COULD RESULT IN PREMATURE BEARING FAILURE.*

7. Tighten the top generator adjusting screw "A" and lock with jam nut, then retighten generator mounting screws "B", make sure all screws are securely tightened.

#### NOTE

*FREQUENTLY CHECK AND RETIGHTEN GENERATOR ADJUSTING AND MOUNTING SCREWS.*

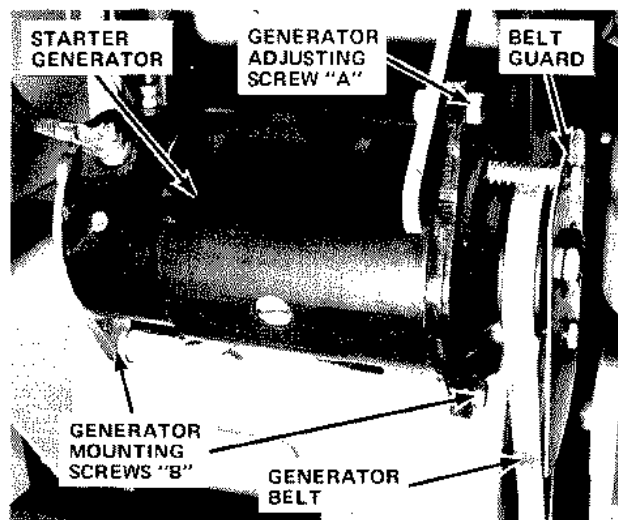

Figure 6

#### STOPPING THE ENGINE

1. If the engine has been operating under a heavy load and is hot, do not stop engine suddenly. Allow it to idle for approximately three to five minutes. This will normalize the engine temperatures more quickly and evenly than stopping the engine suddenly.

2. Turn ignition switch off, put transmission lever in "PARK" position, P.T.O. lever in "OFF" position and remove ignition key.

#### OPERATION

BEFORE DRIVING THE HUSKY, THE OPERATOR SHOULD BE FAMILIAR WITH THE LOCATION AND FUNCTIONS OF ALL CONTROLS. THE ENGINE WILL START ONLY WHEN P.T.O. LEVER IS IN OFF POSITION AND TRANSMISSION LEVER IN PARK OR NEUTRAL.

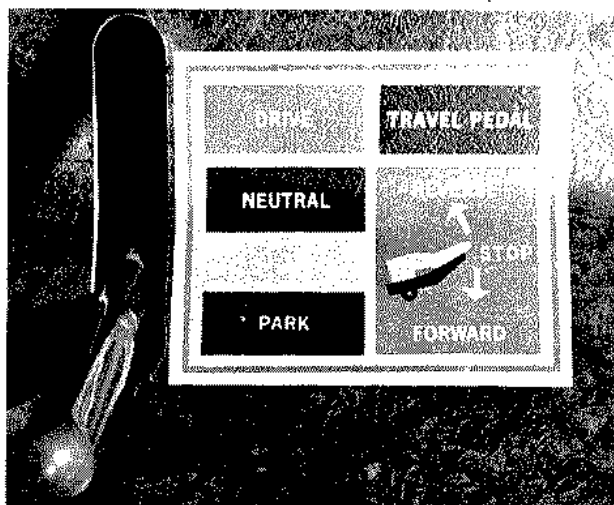

Figure 7

Placing the transmission lever in PARK or NEUTRAL position locks the travel pedal in its centered or neutral position, to prevent use of the travel pedal when selector lever is in PARK or NEUTRAL.

Depress foot brake (Figure 4, Reference 6) and place transmission lever in DRIVE position. ALWAYS DEPRESS FOOT BRAKE PEDAL BEFORE MOVING TRANSMISSION LEVER INTO "NEUTRAL", "PARK" OR "DRIVE" POSITION TO AVOID CREEPING.

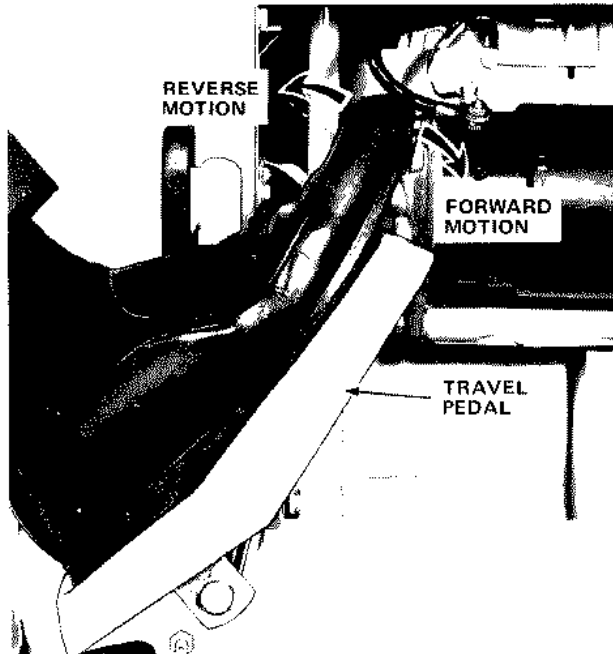

Figure 8

Release brake pedal, and slowly apply pressure to the travel pedal with toe of right foot for forward motion, or if reverse motion is desired, slowly apply pressure to travel pedal with heel of right foot. (See Figure 8.)

The hydraulic lift lever can be maneuvered while vehicle is at rest or in motion. Lift lever to raise and push down on lever to lower attachments. When the lever is released, it will automatically return to NEUTRAL position and hold, except when in the FLOAT position. Push lift lever all the way down to lock in FLOAT position. The FLOAT position must be used when the operator wants the attached implement to follow ground contours independently. (See Figure 9.) Consult your attachment manual for correct lift lever position.

**CAUTION**

*BE SURE ATTACHMENT IS COMPLETELY HOOKED UP BEFORE USING HYDRAULIC LIFT. DAMAGE COULD RESULT. MOVE THE ATTACHMENT THROUGH ITS COMPLETE RANGE SLOWLY TO MAKE SURE IT DOES NOT BIND OR HAVE INTERFERENCE. MAKE NECESSARY ADJUSTMENT IF REQUIRED.*

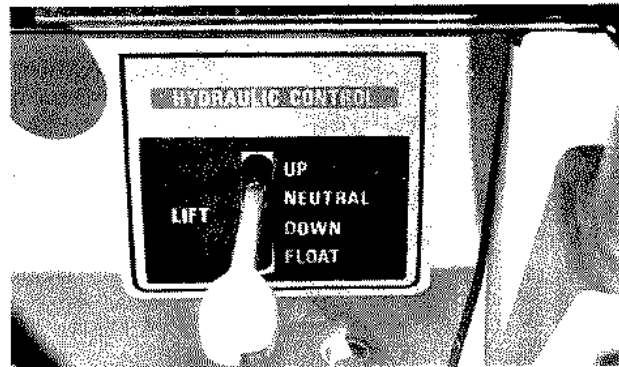

Figure 9

**NOTE**

*THE HYDRAULIC LIFT LEVER, EXCEPT WHEN PLACED IN FLOAT POSITION, SHOULD ALWAYS RETURN TO THE NEUTRAL POSITION AFTER RAISING OR LOWERING OPERATIONS.*

The hydrostatic transmission gives the operator a choice of infinitely variable speeds from 0 to 8 mph forward, and 0 to 4 mph in reverse. Avoid excessive HIGH travel speed whenever possible. Lower travel speeds are best for most jobs such as snow casting or mowing.

It is required that the tractor operate at FULL THROTTLE. While operating under heavy load conditions, listen to the engine RPM. If the engine begins to labor, *do not advance the travel pedal*. By letting up on the travel pedal, the ground speed will decrease and the engine speed will increase, thereby allowing engine to maintain constant P.T.O. speed. (See Figure 10.)

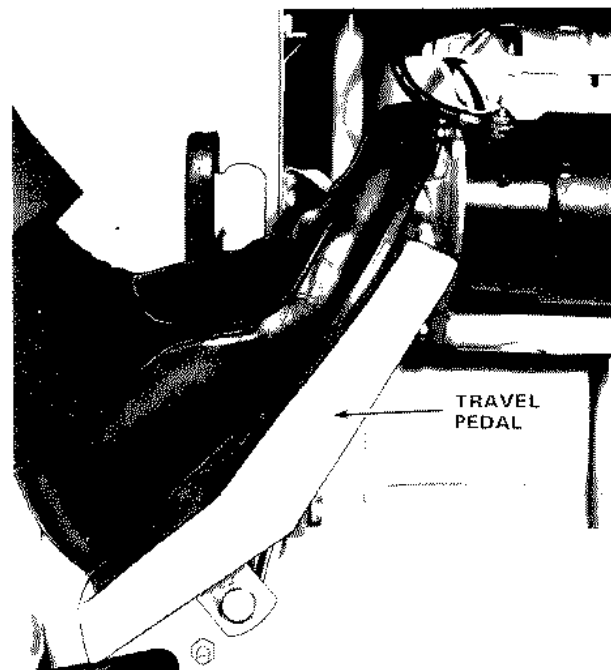

Figure 10

The travel (control) pedal is generally used for dynamic braking. To slow down or stop the tractor while it is in forward motion, gradually apply pressure to the travel control pedal with heel of right foot until tractor comes to a full stop. To slow down or stop the tractor while it is in reverse motion, apply pressure to travel control pedal with toe of right foot until tractor comes to a full stop.

**CAUTION**

*DO NOT ATTEMPT TO PLACE TRANSMISSION LEVER IN PARK POSITION UNTIL TRACTOR HAS COME TO A FULL STOP. MECHANICAL DAMAGE CAN RESULT.*

SHOULD ENGINE STALL WHEN SHIFT LEVER IS IN DRIVE, TRAVEL PEDAL MUST BE BROUGHT BACK TO NEUTRAL POSITION, TO SHIFT LEVER INTO NEUTRAL OR PARK, TO RESTART MOTOR.

When towing the tractor, place the transmission lever in NEUTRAL position only. DO NOT EXCEED SPEED OF 5 MPH WHILE TOWING. Use foot brake pedal to stop vehicle when towing.

**RUN-IN PERIOD**

BEFORE OPERATING THE TRACTOR AT FULL LOAD, IT SHOULD BE OPERATED AT ONE-HALF THROTTLE FOR APPROXIMATELY ONE-HALF HOUR WITH NO LOAD APPLIED. AFTER THE FIRST HALF-HOUR OF OPERATION, RUN THE TRACTOR AT FULL THROTTLE WITH NO LOAD APPLIED FOR AN ADDITIONAL TWO HOURS.

ATTACH A LIGHT LOAD TO THE TRACTOR. OPERATE THE TRACTOR WITH LIGHT LOAD FOR A PERIOD OF APPROXIMATELY FIVE HOURS AT FULL THROTTLE. THE TRACTOR IS NOW READY FOR NORMAL LOAD OPERATION.

**NOTE**

*ALWAYS OPERATE THE ENGINE AT FULL THROTTLE FOR BEST ATTACHMENT PERFORMANCE. CONSULT YOUR ATTACHMENT MANUALS FOR SPECIFIC INSTRUCTIONS.*

**PREVENTIVE MAINTENANCE**

A little time spent each day by the operator on preventive maintenance will lead to longer operating life of the HUSKY.

The removal of debris, dirt and grease accumulations are considered normal maintenance practices and can help discover minor difficulties before they become troublesome.

**ENGINE** — Remove ignition key. Remove all dirt from around engine fins, base of spark plug and crankcase oil dipstick. A gap of .030 inch should be maintained between spark plug electrodes. See Engine Manufacturer's Manual for further maintenance of engine.

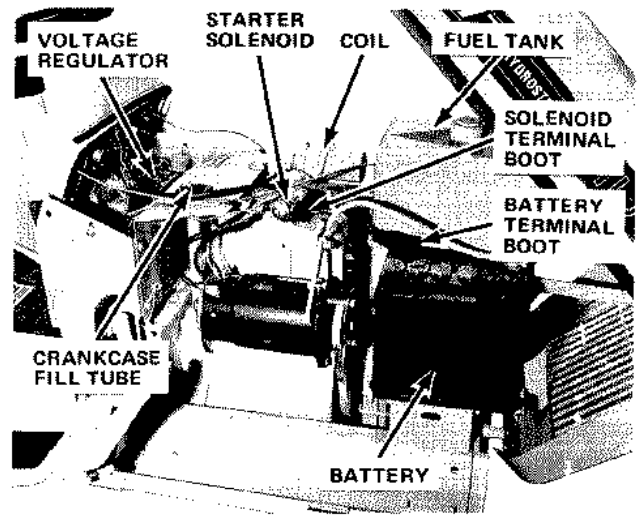

Figure 11

**CAUTION**

*CLEANING OF SPARK PLUGS IN MACHINES THAT USE ABRASIVE GRIT IS NOT RECOMMENDED. SPARK PLUGS SHOULD BE CLEANED BY SCRAPING OR WIRE BRUSHING AND WASHING WITH A COMMERCIAL SOLVENT.*

**HYDROSTATIC TRANSMISSION** — Remove ignition key. Remove all dirt from around transmission filler plug area and filter. Clean transmission cooling fins periodically. If tractor is operated in a dusty environment, check and clean cooling fins more frequently. Consult your Bolens dealer for transmission maintenance. (See Figures 12 and 13.)

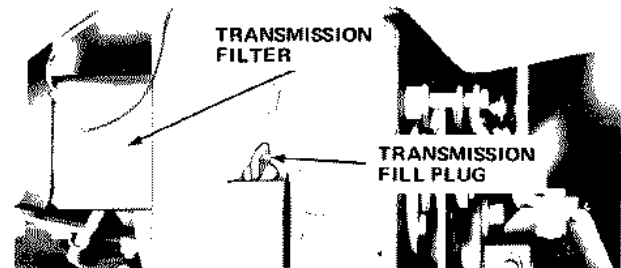

Figure 12

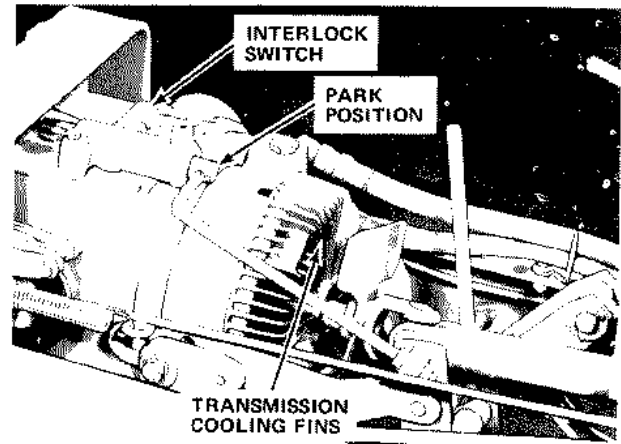

Figure 13

## FRONT WHEEL BEARINGS —

1. Remove hub cap.
2. Remove cotter pin and unscrew slotted nut.
3. Remove bearing.
4. Pack bearings with the lubricant called out in the Lubrication Section of this manual.
5. Install bearing.
6. Turn slotted nut on spindle hand-tight, test-spin wheel to align bearings, then back nut off to nearest slot in line with hole in spindle, and install a new cotter pin.
7. Press on hub cap.

**AIR CLEANER** — See Engine Manufacturer's Manual and decal "VERY IMPORTANT" on air cleaner. (See Figure 14.)

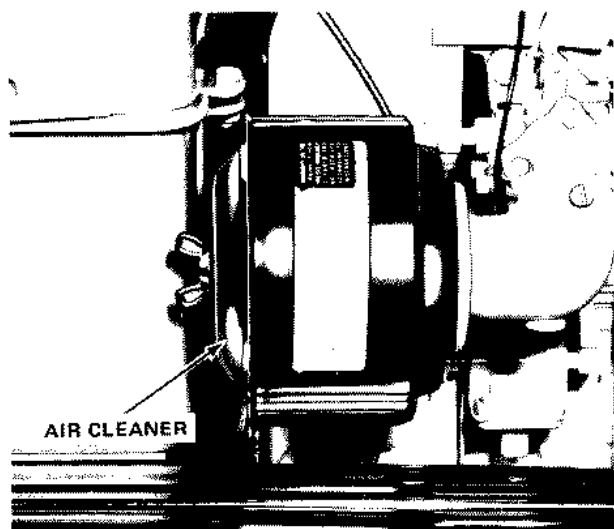

Figure 14

**FUEL TANK** — Fill with clean fresh gasoline of regular grade. (For cold weather operation use winter blend gasoline.) **DO NOT MIX OIL WITH GASOLINE. REFUEL OUTDOORS WITH ENGINE STOPPED AND COOL.**

Check to see that vent hole in fuel tank cap is not plugged.

**GENERATOR** — Keep terminals tight and clean. Check belt for wear. Adjust tension or replace belt if badly worn.

**BATTERY** — Keep cables and terminals clean and apply a light coat of petroleum jelly or oil for protection. Check battery bracket for corrosion and keep clean. Do not *over-tighten* battery mounting. Reinstall in same position.

## IMPORTANT

*WHEN SERVICING THE BATTERY, BE SURE BATTERY CABLES ARE DISCONNECTED BEFORE ATTEMPTING REMOVAL OF THE BATTERY FROM THE TRACTOR. ALWAYS DISCONNECT GROUND (-) CABLE FIRST. WHEN INSTALLING THE BATTERY, ALWAYS CHECK THE POLARITY OF THE BATTERY TERMINALS TO BE SURE THE BATTERY IS NOT REVERSED. THE NEGATIVE TERMINAL (-) IS GROUND. APPLY A LIGHT COAT OF PETROLEUM JELLY OR OIL TO THE INSIDE OF THE CLAMP TERMINALS AND OVER THE BOLT STUD BEFORE CONNECTING TERMINALS. ALWAYS CONNECT THE GROUND TERMINAL (-) LAST. SHOULD IT BECOME NECESSARY TO REMOVE THE BATTERY WHEN REINSTALLING IT: (1) Place hold down rods in place. (2) Tighten wing-nuts (FINGER TIGHT ONLY) to avoid possible damage to battery case.*

The electrolyte (acid and water) in each cell should be at triangle level at all times to prevent battery failure. When the electrolyte is below this level, *add pure, distilled water.*

**UNDER NO CIRCUMSTANCES ADD ANY SPECIAL BATTERY "DOPES", SOLUTIONS OR POWDERS OR EXOTIC ADDITIVES; THIS VOIDS WARRANTY.**

### CAUTION

*ELECTRIC STORAGE BATTERIES GIVE OFF HIGHLY INFLAMMABLE HYDROGEN GAS WHEN CHARGING AND CONTINUE TO DO SO FOR SOME TIME AFTER RECEIVING A STEADY CHARGE. DO NOT UNDER ANY CIRCUMSTANCES ALLOW AN ELECTRIC SPARK OR AN OPEN FLAME NEAR THE BATTERY. DO NOT LAY TOOLS ACROSS BATTERY TERMINALS AS THIS MAY RESULT IN A SPARK OR SHORT CIRCUIT WHICH MAY CAUSE AN EXPLOSION. BE CAREFUL TO AVOID SPILLING ANY ELECTROLYTE ON HANDS OR CLOTHING.*

**VOLTAGE REGULATOR** — Keep terminal connections tight and clean. Consult your dealer for servicing adjustments or repairs.

**STARTER SOLENOID** — Keep terminal connections tight and clean. Make sure terminal does not twist while tightening nut.

**PNEUMATIC TIRES** — Keep both front and rear tires inflated evenly. Under no circumstances should tire inflation be less than 8 pounds. 8-12 PSI recommended. Check air pressure regularly with a low pressure gauge. Over or under inflation will result in tire failures.

## ADJUSTMENTS

For adjustments not discussed in this manual, consult your Bolens dealer.

### FRONT AXLE STOP

If the clearance between the Front axle assembly "A" and the Stop assemblies "B", Figure 16, is 1/16 inch or more the stops must be adjusted.

- A. Loosen capscrews "A", Figure 15.
- B. Move Stop assemblies "B," Figures 15 and 16, up against Front axle assembly "A," Figure 15.
- C. Secure capscrews "A", Figure 16.

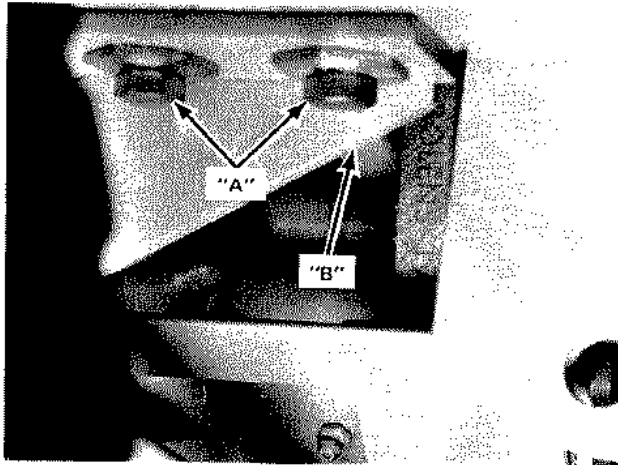

Figure 15

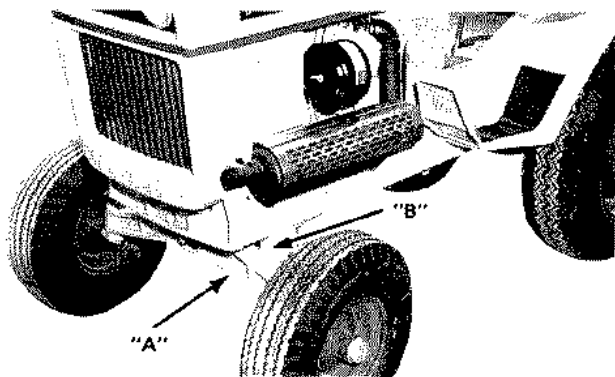

Figure 16

STEERING ADJUSTMENT (See Figure 17).

1. Turn steering wheel so that front wheels are straight ahead.
2. Disconnect R.H. side of tie rod from steering arm. Measure distance across front of front tires, center line to center line, and adjust toe in from 0 to 3/8" maximum by turning tie rod in or out as required. (Front reading should be less than rear reading when measured across tire center lines.)

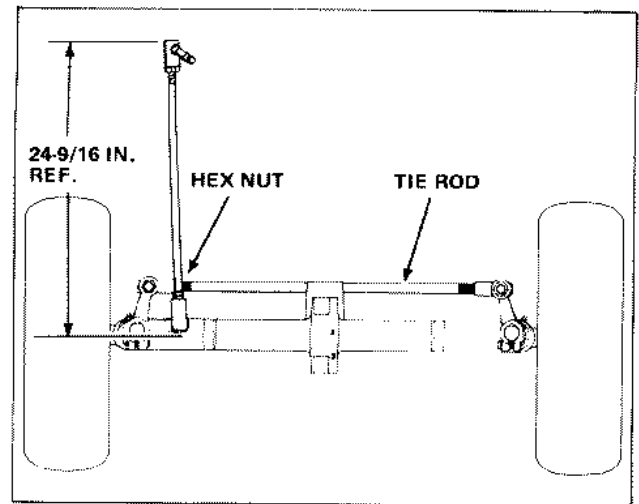

Figure 17

3. Tighten hex nut securely, and secure tie rod into steering arm making sure lockwasher is between ball joint and arm.
4. Check length of steering drag link. Overall length should be approximately 24-9/16 inches. Adjust if necessary.

### TURNING RADIUS

5. Adjust turning radius if, in making short turns, a front tire interferes with front mounted attachment brackets or center mounted attachments. Adjusting screws are provided, as follows:

A. You will find a slot in the right hand frame at the rear of the steering drag link where it connects to the steering gear. (See Figure 18.) Near each end of this slot is a square head setscrew, with lock nut, inserted in the frame.

B. The screw at the front of the slot area controls the LEFT turning radius. The screw at the rear controls the RIGHT turning radius.

C. Turning these screws IN will increase the tractor turning radius. Turning screws OUT will decrease the radius.

### IMPORTANT

*ADJUST SCREWS SO THAT TRACTOR TURNING RADIUS IS APPROXIMATELY THE SAME, LEFT AND RIGHT.*

6. Check to make sure the stops are being used.

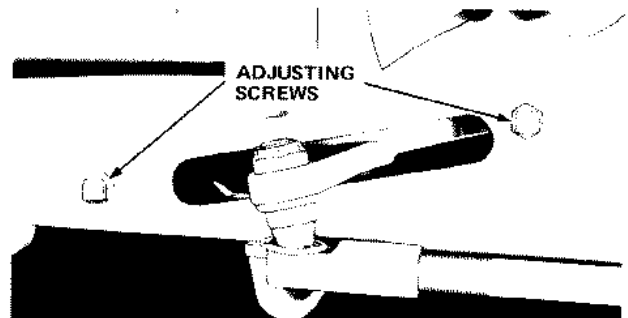

Figure 18

## POWER TAKE-OFF (P.T.O.) LEVER (See Figure 19)

1. Place P.T.O. lever in the OFF position.
2. Remove spring cotter pin and turn the P.T.O. control rod in until the desired tension is obtained, or the "over-the-center" snap is felt when moving the P.T.O. lever from OFF position to ON position. Reinstall spring cotter pin.
3. With the P.T.O. lever still in the ON position, loosen the hex capscrew which secures the upper belt guide shown in Figure 20. Adjust upper belt guide for 1/8 to 1/4 inch clearance between belt and belt guide. Tighten hex capscrew securely.

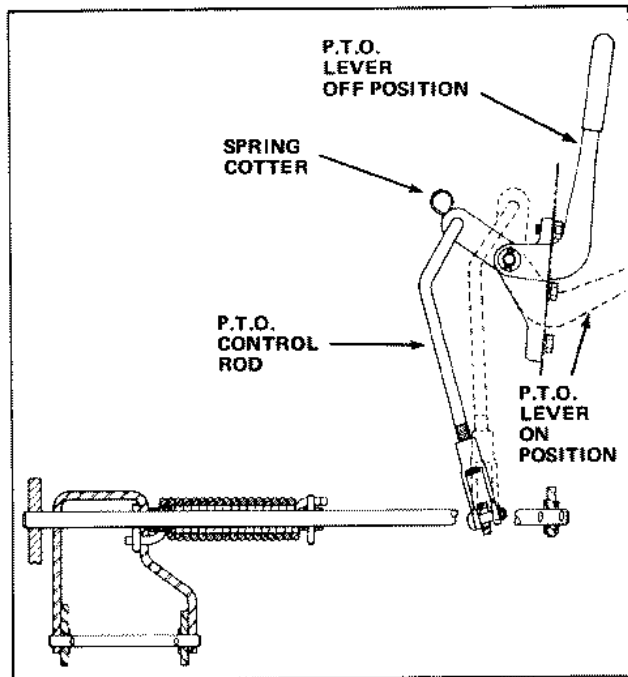

Figure 19

## P.T.O. BELT ADJUSTMENT (See Figure 20)

Should it become necessary to replace P.T.O. belt, install new belt as follows:

1. Place P.T.O. lever in the OFF position.
2. DO NOT disturb upper belt guide, if 1/8 to 1/4 inch gap is evident with P.T.O. lever in the "ON" position.
3. Remove lower belt guide.
4. With hood open, place the three NEW BELTS over both ENGINE and IDLER pulley with your right hand while feeding belts up from below with left hand, then feed into grooves of P.T.O. pulley.
5. Reinstall lower belt guide and adjust for a 3/32 to 1/8 inch clearance between belt guide and belts with P.T.O. lever in the "ON" position. Tighten the two hex capscrews securely. Check upper belt guide and adjust if necessary. Place P.T.O. lever in OFF position.

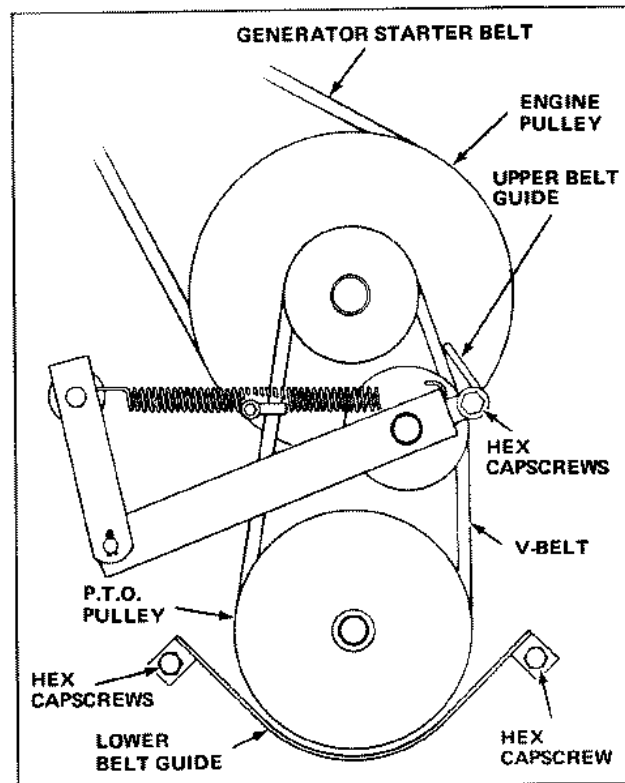

Figure 20

## DISC BRAKE (See Figures 21 and 22)

1. Remove cotter pin and clevis pin from brake rod assembly.
2. Hold brake pedal in its normal relaxed position. Turn end yoke until one inch maximum free brake pedal travel is attained before pedal depression gives braking action.
3. Reinstall clevis pin and secure with cotter pin.

### NOTE

*BEFORE ADJUSTING, INSPECT DISC BRAKE ASSEMBLY TO DETERMINE WHETHER AN ADJUSTMENT IS NEEDED OR IF BRAKE PAD REPLACEMENT IS NECESSARY. FOR DISC BRAKE SERVICE, CONSULT YOUR BOLENS DEALER.*

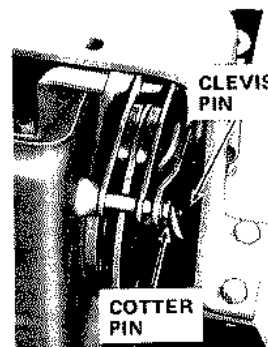

Figure 21

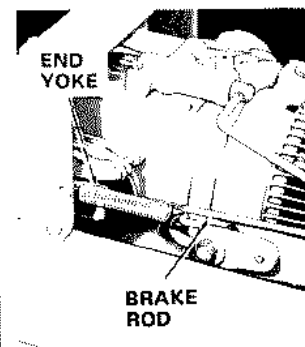

Figure 22

## SEAT ADJUSTMENT (4 positions available)

The 1477 tractor features adjustable seat spring suspension. Leaf springs can be added or removed from the seat as desired by the operator. If additional leaf springs are desired, order them through your Bolens dealer.

### Seat Adjustment

1. Tilt seat forward.
2. Remove spring cotter pins shown in Figure 23.
3. Lift seat; using one of the two holes provided, position adjusting blocks as shown in Figure 23 for the front two seat positions. To move seat back, rotate adjusting blocks 180 degrees, and use either of the two sets of holes provided.
4. Reinstall spring cotter pins.

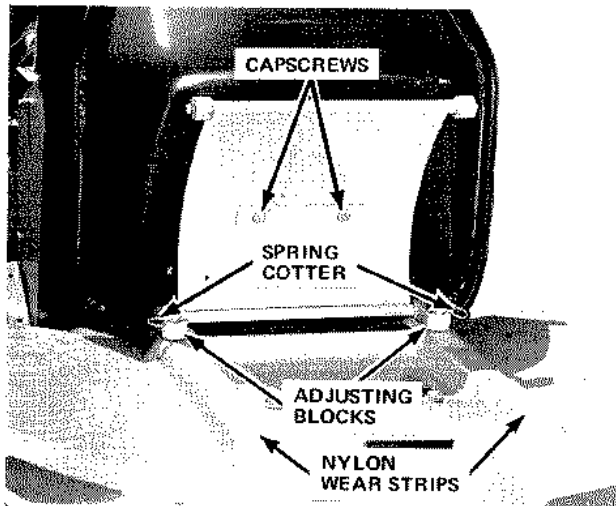

Figure 23

### Leaf Spring Adjustment

1. Tilt seat forward, and brace to prevent it falling.
2. Remove the two hex nuts shown in Figure 23 then add or remove leaf springs as desired.
3. Reinstall hex nuts and tighten securely.

### Seat Removal

To remove the seat, remove the two spring cotter pins shown in Figure 23, and lift seat from tractor.

### Travel Pedal Adjustment

The travel pedal angle can be adjusted for the operator's comfort. Refer to Figure 24.

- A. Loosen two nuts "A" and nut "B".
- B. To bring toe of pedal closer to operator, shorten rod "C".
- C. To reverse, lengthen rod "C".
- D. Lock nuts "A" and "B" securely after desired adjustment is reached.



Figure 24

## LUBRICATION

Proper lubrication and regular maintenance will increase the operating life of your HUSKY and attachments. Negligence on the part of the operator in regard to regular lubrication or general maintenance can depreciate the dependability of this vehicle and void warranty. It is suggested that lubrication recommendations in this manual be followed. A lubrication record prepared by the operator would be beneficial.

The numerically listed locations on the lubrication chart correspond to those numbers shown on Figures 25 and 26.

### LUBRICATION CHART

LOCATION	TYPE OF LUBRICATION	AMOUNT OF LUBRICATION	FREQUENCY OF LUBRICATION
1. Wheel Bearings	Wheel Bearing Grease	Pack	Once a year
2. Front Wheel Spindles	Gun Grease	As Req'd.	8 hrs.
3. Front Axle Pivot	Gun Grease	As Req'd.	8 hrs.
4. P.T.O. Housing	Gun Grease	As Req'd.	8 hrs.
5. Air Cleaner	See Engine Manufacturer's Manual & Decal on Cleaner		
6. Engine Oil Drain Plug	Located on left hand side of lower engine block		
*7. Disc Brake Linkage	Oil	Coat surfaces	25 hrs.
●*8. Hydrostatic Transmission	Automatic Transmission Fluid - Type A	Add to plug level	Check once a week or 25 hrs.
9. Transmission Filter			Change every 300 hrs. or with oil change
10. Hood Hinge	Oil	Coat surfaces	25 hrs.
11. Generator-Starter	No lubrication required		
*12. Universal Joints	Gun Grease	One stroke of grease gun	△
13. Pivot Shaft (2 Fittings)	Gun Grease	One stroke of grease gun	8 hrs.
*14. Travel Pedal Pivot Shaft & Bearings	Oil	Coat surfaces	25 hrs.
*15. Engine Crankcase	See Engine Manufacturer's Manual		
<p>● Capacity 10 quarts. See your dealer for specified oil for complete refills.            * More frequent if application demands.            △ Grease every 250 hours or once each year, whichever occurs first.</p> <p>NOTE: For best access to grease fitting on front universal (remove spark plug wire), place transmission lever in neutral and rotate driveshaft until opening with grease fitting faces the left side of tractor. With the grease gun and hose assembly specified below, the nozzle will just fit through the opening and onto the grease fitting. A small amount of extra hand pressure might be needed to press nozzle onto fitting.</p> <p>NOTE: A hand type grease gun with a flexible hose is recommended when greasing your unit. This type grease gun can be purchased at most automotive supply stores. Ask for Alemite All Purpose Grease Gun No. 4031 with Flexible Hose Assembly No. 6703A, or similar type. <u>Hi-pressure type grease guns</u> could cause damage to the fittings and bearing seals. Lubricate all linkages, levers and pins not equipped with grease fittings with an oil can once a week, or oftener depending on operating conditions.</p>			



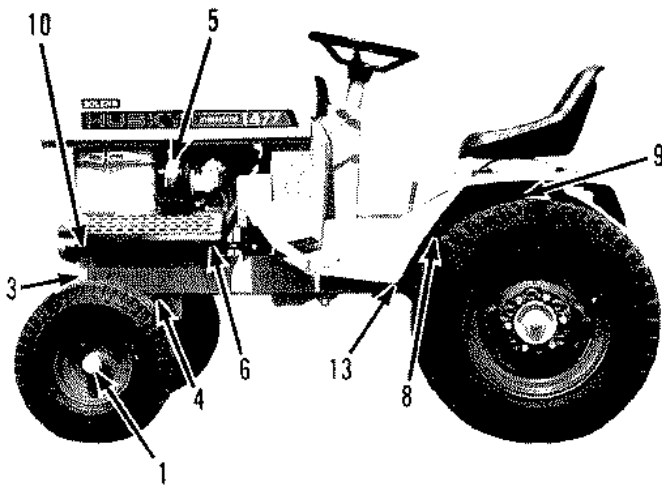
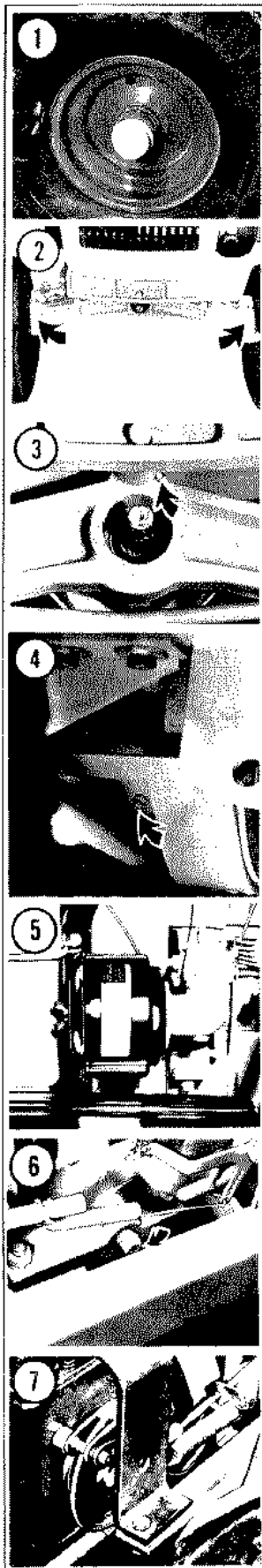

Figure 25

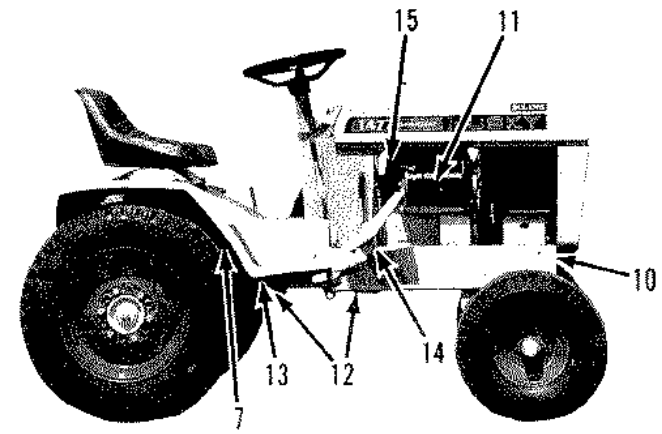
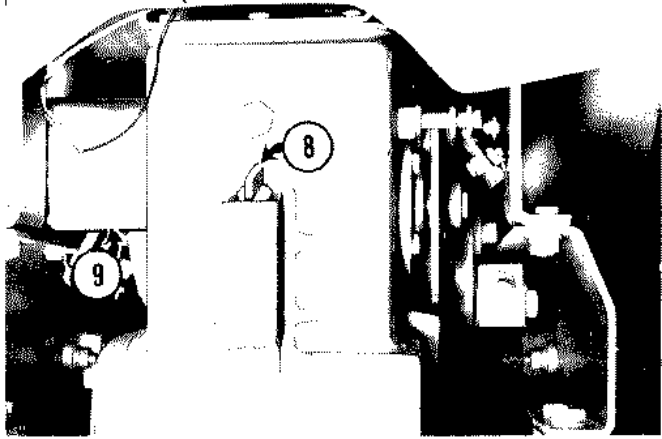
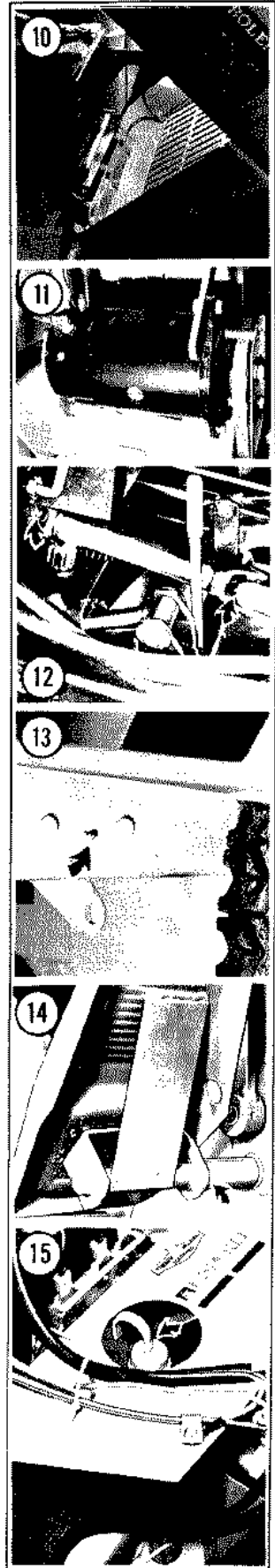

Figure 26



## MINOR TROUBLE SHOOTING GUIDE

IF TRACTOR ACTS IN FOLLOWING MANNER:	CHECK FOR POSSIBLE CAUSE												
	CLEAN OFF ENGINE FINS	FAULTY IGNITION*	FAULTY SPARK PLUG	EMPTY FUEL TANK	BATTERY	CARBURETOR	OIL	AIR CLEANER (CLEAN)	CHOKE	SEE YOUR BOLENS DEALER	CONTROLS ADJUSTED INCORRECT	CONTROLS NOT IN CORRECT POSITION	CHECK INTERLOCK SWITCHES
Engine will turn over but won't start		X	X	X		X			X	X			
Engine will not turn over					X					X		X	X
Starts only after repeated tries		X	X			X			X	X			
Stalls in a few seconds				X		X				X			
Stalls when hot	X	X	X	X		X	X	X		X			
Idles rough		X	X			X		X	X	X			
Engine overheats	X	X				X	X	X		X			
Can not put transmission control in neutral or park										X	X	X	

\* See your Bolens Dealer.

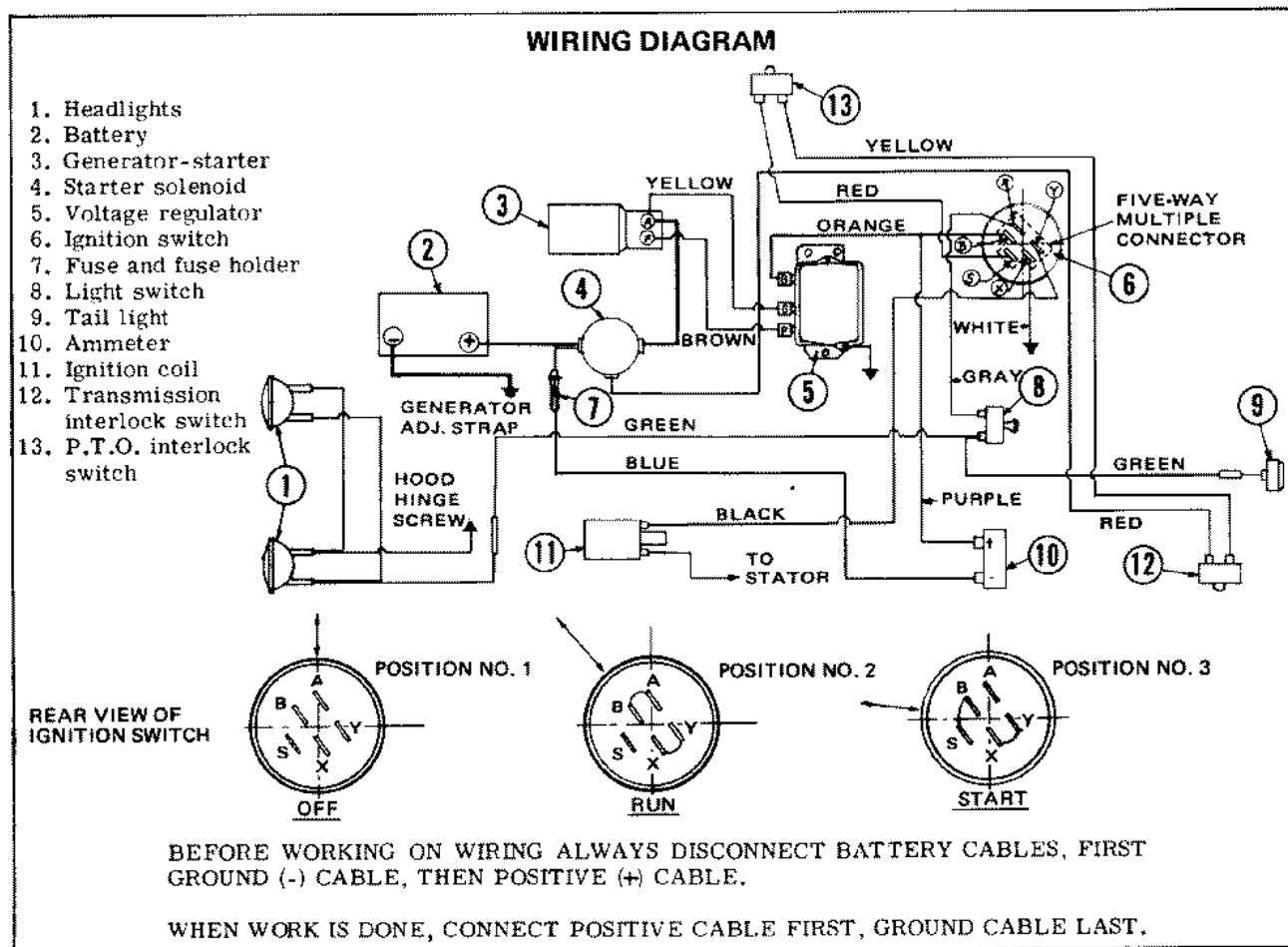

OPTIONAL EQUIPMENT

REAR TIRES

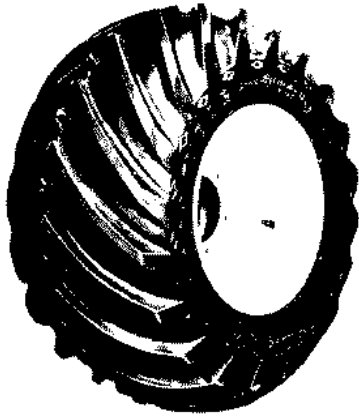

TERRA TIRE KIT (26 x 12.00-12)  
MODEL NO. 18017-01

Figure 28

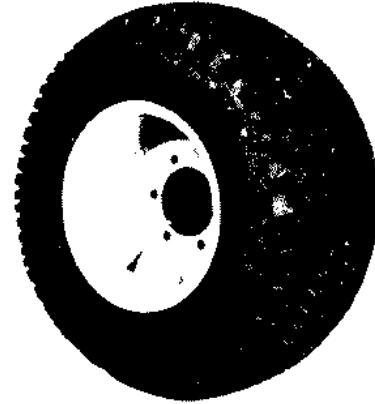

LAWN & GARDEN TERRA TIRE KIT  
(26 x 12.00-12)  
MODEL NO. 18016-01

Figure 29

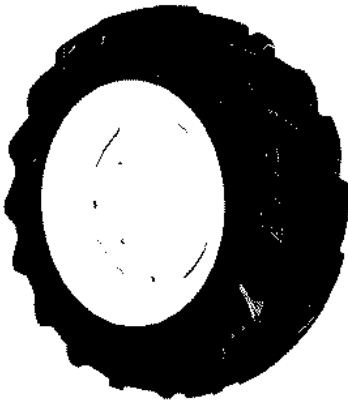

STANDARD AGRICULTURAL TIRE  
KIT (27 x 8.50-15)  
MODEL NO. 18019-01

Figure 30

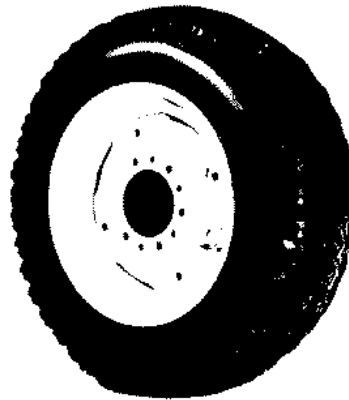

STANDARD LAWN & GARDEN TIRE  
KIT (27 x 8.50-15)  
MODEL NO. 18018-01

Figure 31



DUAL WHEEL KIT (27 x 8.50-15)  
MODEL NO. 18020-01

Figure 32

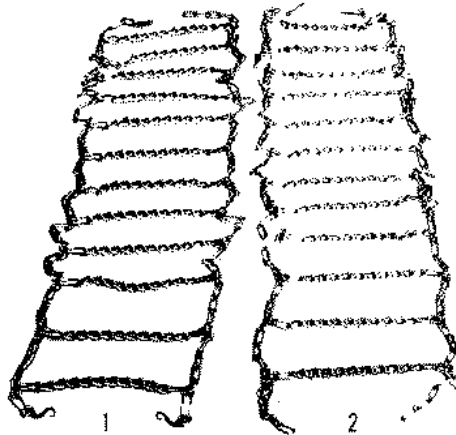

TIRE CHAINS

- (1) Model No. 19614-01 - For 26 x 12.00 - 12 Tire
- (2) Model No. 19613-01 - For 27 x 8.50 - 15 Tire

Figure 33

## POWER TAKE-OFF (P.T.O.)

Drive shaft delivers power directly from power take-off (P.T.O.) to attachment-front, rear and center-mounted. Switching powered attachments requires only a short time. Grease Power Take-off shaft then slide universal joint over end of shaft until lock collar snaps into groove.

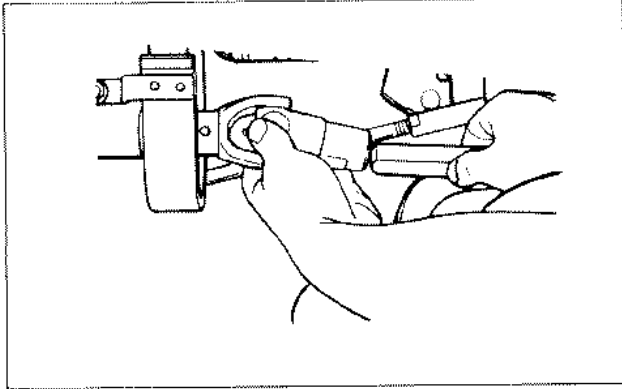

Figure 34

Grease square shaft of universal drive shaft. Slide attachment drive and P.T.O. drive shaft universal joint together; install pins into hitch points. The P.T.O. (power take-off) drive shaft is located under the front of the tractor frame and is connected to the engine by three drive belts. This assembly has a drive shaft which is splined at both ends so that front, center and rear power attachments can be coupled directly to it. Universal joints on the attachments are equipped with needle-bearings allowing you to raise or lower attachments (with hydraulic lift lever) while the tractor is under full power.

Your HUSKY Tractor has the fastest attachment switch system in the industry. No belts to install...no special tools needed.



**ALWAYS REMOVE UNIVERSAL JOINT FROM POWER TAKE-OFF SHAFT WHEN ATTACHMENTS ARE REMOVED FROM TRACTOR. IF THE JOINT IS NOT REMOVED AND THE POWER TAKE-OFF IS ENGAGED, DAMAGE WILL RESULT FROM WHIPPING ACTION OF THE FREE JOINT, AND PERSONAL INJURY COULD OCCUR.**

## WHEEL WEIGHT KIT

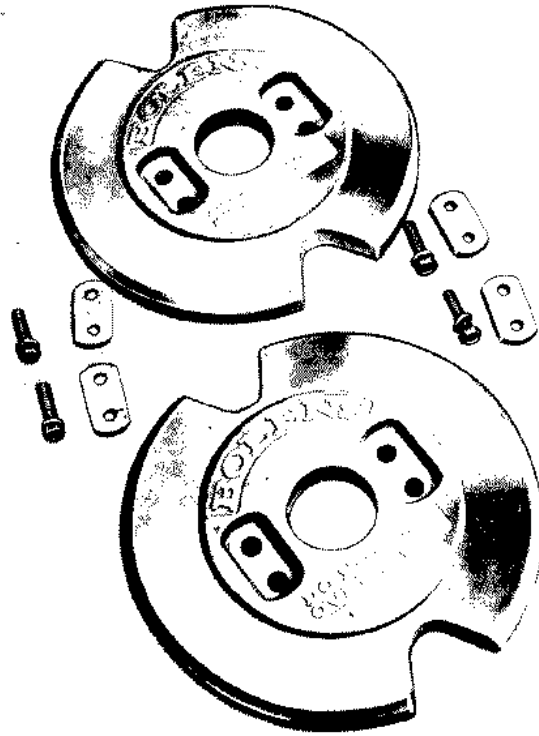

Figure 35



**DO NOT INSTALL MORE THAN THREE WHEEL WEIGHTS TO ONE WHEEL. (SEE FIGURE 35.)**

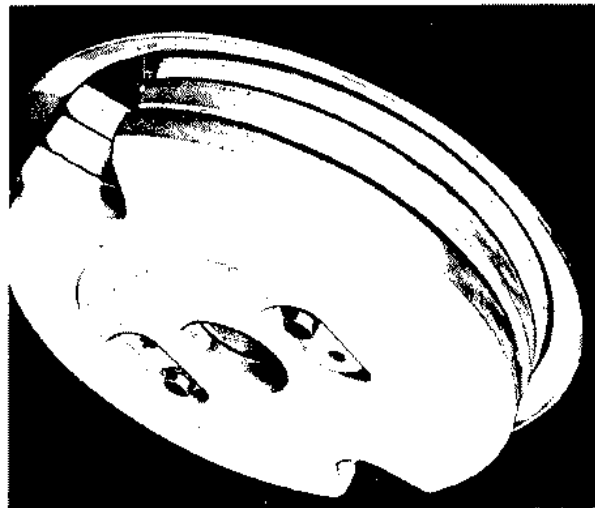

Figure 36

## MAINTENANCE GUIDE

	EVERY 10 HOURS OF OPERATION	EVERY 25 HOURS OF OPERATION	EVERY 50 HOURS OF OPERATION
Check battery	X*	If tractor is stored, battery charge should be checked every 60 days and recharged if necessary.	
Check air in tires (8 to 12 lbs.)		X*	
Check engine crankcase oil	See Engine Manufacturer's Manual		
Drain engine crankcase oil (left side of engine)			X*
Check transmission oil with engine idling (add to filler plug level as needed)		X*	
Check and clean cooling air screen (see Figure 14)	X*		
Lubrication points (see Lubrication Chart)	X*		
Check generator-starter mounting bolts	X		
Check for belt wear			X
Check and clean cooling fins of transmission	X*		
* Varies depending on operating conditions, climate, etc.			

## STORING YOUR HUSKY TRACTOR

Always keep your HUSKY tractor in a dry protected place when not in use to prolong its usefulness and appearance. With year around use, it is not necessary to "store" the tractor; but when it is not to be used for some time, it should be prepared for storage in the following manner:

1. Completely clean all accumulated dirt or trash from all parts, especially engine fins, and transmission fins.
2. Wipe oil or a rust preventive on any parts that may rust.
3. Drain gas tank and carburetor.
4. Remove, clean and regap spark plug and pour a small amount of oil (SAE 30) into cylinder. Consult Engine Manufacturer's Manual.
5. Without starting the tractor, turn the engine over a few times to fully lubricate the cylinder walls, valve seats and

valve stems. This can be done by engaging the key starter briefly. Replace spark plug.

6. Keep tractor covered.

7. BATTERY — Each week fill each cell to triangle with distilled water. Keep terminal posts cleaned of corrosion salts and coat with petroleum jelly or grease. Keep cables clean. Stored battery must be kept fully charged and with all cells filled to triangle. Store at cool temperature, 20<sup>o</sup> to 50<sup>o</sup>. Check each two months and charge as necessary.

8. The air cleaner should be cleaned and sealed off with a plastic bag or facsimile, for the duration of the storage period.

9. If tractor is stored with an attachment mounted on it, the attachment MUST be lowered to the ground, and P.T.O. lever put in OFF position.

---

Bolens reserves the right to change specifications, add improvements, or discontinue the manufacture of any of its equipment without notice or obligation to purchasers of its equipment when equipment was purchased prior to decision to make changes, add improvements, or discontinue manufacture.

Bolens approval of the use of attachments manufactured by other manufacturers is limited to assurance that such use will not void Bolens warranty on the Bolens equipment to which the outside manufactured attachments are adapted. The responsibility for the design, performance, durability, safety and operation, service repair availability, and warranty obligation remain with the outside manufacturer. Bolens specifically excludes from its warranty obligation all such outside manufactured attachments.

Bolens warranty will be voided if unapproved attachments are adapted to use with Bolens equipment and are so used.

---

# LUBRICATION AND MAINTENANCE RECORD

DATE PERFORMED	DESCRIPTION OF MAINTENANCE	HRS. RUN



PORT WASHINGTON, WISCONSIN, U.S.A.