

**operator's manual
and
maintenance
instructions**

HUSKY TRACTOR

**1455
HYDROSTATIC**

MODEL 198-02

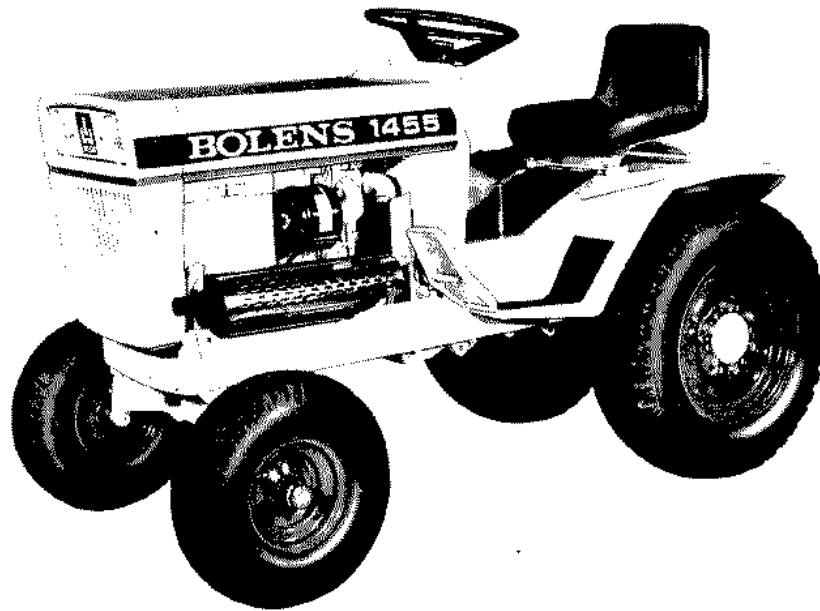

BOLENS

PORT WASHINGTON, WISCONSIN, U.S.A.

MyTractorForum.com

GENERAL SAFETY PRECAUTIONS

Preventing accidents is the responsibility of every equipment operator. The following general safety precautions must be fully understood and followed by every operator of this tractor and its attachments. Review them frequently and NEVER TAKE CHANCES. BE CAREFUL BEFORE, DURING AND RIGHT AFTER USE OF ANY POWERED EQUIPMENT. ACCIDENTS CAN BE PREVENTED.

1. Mount vehicle, place transmission shift lever in PARK and put P.T.O. lever in OFF position prior to starting engine. Engine will not start unless transmission lever is in PARK and P.T.O. lever is in OFF position.
2. Do not mount or leave vehicle while it is in motion or in actual operation, nor leave vehicle unattended while engine is running. Injury to the operator or a tractor run-away could occur.
3. Always shut off engine, remove key, and place transmission lever in PARK whenever vehicle is to be left unattended. Lower all attachments to the ground and put P.T.O. lever in OFF position when leaving the unit unattended, to prevent injury to bystanders.
4. Attachments must be lowered to the ground when storing tractor, to prevent the attachment from being dropped accidentally and causing injury. Put P.T.O. lever in OFF position.
5. Do not tow vehicle over 5 miles per hour. Damage to the vehicle could occur.
6. When towing or moving the vehicle, place transmission lever in NEUTRAL. Do not tow with attachments on vehicle. Damage to the transmission or attachment could occur.
7. Do not carry passengers. The passengers could fall off vehicle receiving injuries.
8. Keep hands clear of transmission cooling fan. The fan could cause serious injury when running.
9. Do not start or operate vehicle in an inside area, unless it is adequately ventilated. Engine exhaust contains carbon monoxide fumes, which are very poisonous.
10. Keep tractor and attachments free of excess grease and oil. The unit will operate cooler, be easier to maintain, and safer to operate.
11. Engine must be stopped, and P.T.O. disengaged when cleaning, servicing, adjusting, repairing, or installing attachments on tractor. This is necessary to avoid possible injury from moving parts.
12. Always disconnect ground (-) battery cable from battery before doing any work on the electrical system. Reconnect it LAST when work is done. This is to prevent accidental burns and shorting of electrical system.
13. Study your manual. Know your tractor before operating it. Take time to operate the unit in the safest manner.
14. Always follow manufacturer's operational suggestions.
15. Do not allow children to operate vehicle at any time. The average child is not mentally capable of coping with the intricacies of operating a power tool.
16. Do not fill gasoline tank when engine is running or hot. Add gas (using funnel) only outdoors and when engine is cool. KEEP SMOKERS AWAY FROM UNIT WHILE FUELING. This will help eliminate the possibility of fire and/or explosion from spilled gasoline or fumes.
17. Do not allow adults to operate vehicle without proper instructions including all safety instructions. In doing so, you will be sure they know how to operate unit properly and also are aware of all the safety precautions.
18. Store fuel in approved tightly closed container out of reach of children. Gasoline is highly flammable and the fumes highly explosive.
19. Never operate tractor with mower, snow caster, or any other attachment having moving parts, when any child or person is in travel path or discharge area. Children must not be allowed in or near working areas when equipment is being used. Items or objects such as wire, stones, small toys and etc. can be ejected at high velocity out of the discharge chute.
20. Always look back to be certain no one is in the way before using reverse. This will avoid the possibility of running over any children, persons or pets who might be in the area in back of the vehicle.
21. Study all attachment manuals thoroughly before using attachments with tractor, to be aware of both the tractor and attachment capabilities when used as a unit, also the safest manner in which to operate them.

THE ENGINE WILL START ONLY WHEN P.T.O. CONTROL LEVER IS IN "OFF" POSITION AND TRANSMISSION LEVER IS IN "PARK" OR "NEUTRAL" POSITION.

ENGINE CAUTIONS

Do not race or gun engine to hurry warm-up after starting, but idle it a few minutes; this will give the oil a chance to circulate through the engine.

Do not operate the engine at any time with cooling shroud removed; this will prevent proper cooling of engine.

To prevent overheating of the engine, and/or possible damage to the engine, check cooling air screen, fan, and engine cooling fins every 10 hours for debris, dust and dirt and clean thoroughly. Under severe dust or dirt conditions the above should be checked and cleaned at more frequent intervals.

Check and service air cleaner after 10 hours or oftener under severe dust and dirt conditions. Service air cleaner as instructed in engine manufacturer's manual. Failure to keep air cleaner clean would allow abrasive particles to enter the engine causing severe damage. Also, a dirty air cleaner would prevent the proper air fuel mixture causing the engine to overheat and cause consequent damage to the engine.

After every 8 hours of operation check oil level. For correct grade of oil and proper oil level, see engine manufacturer's manual. If the oil in the crankcase is allowed to remain below the required

level damage to the engine bearings, cylinder walls, pistons and other moving parts could result from overheating.

After every 50 hours of operation or oftener under severe conditions, the engine crankcase should be drained and refilled with fresh oil. See engine manual for proper specifications and quantity of oil.

On units with a gasoline strainer, the strainer should be inspected frequently. If dirt and water are present in the bowl, the bowl and screen should be removed and cleaned. When reassembling strainer be sure gasket is in good condition; use a new gasket if necessary.

When stopping engine do not stop abruptly, but idle the engine at low RPM for 3 to 5 minutes. The engine will cool down faster at idle and minimize the danger of overheating.

SPARK PLUG

The spark plug should be cleaned inside and out and regapped every 100 hours or once each year whichever occurs first. Check engine manual for correct gap setting. Replace plug whenever necessary. See engine manual for correct plug specifications.

TO THE OWNER

This is an operational and general maintenance manual only and does not cover major repair. All major repair work must be performed by an authorized BOLENS DEALER or the factory warranty is void. Bolens equipment is carefully engineered to give good performance if properly operated and maintained. Keep your equipment clean and lubricate it as prescribed in this manual. Frequently inspect your unit and perform any upkeep maintenance necessary. Check for loose or missing hardware, needed oil or lubrication, damaged parts, etc.

Your dealer is obligated by the factory to completely assemble and service new equipment prior to first delivery, and thoroughly explain and demonstrate its operation. He will repair or replace any parts which fail due to defective material and/or workmanship during the warranty period, and also provide future repair service and supply genuine factory repair parts.

IN EVENT OF ANY PROBLEM OR PARTS REQUIRED ALWAYS CONTACT YOUR DEALER. DO NOT RETURN PARTS TO THE FACTORY. WE REQUIRE PRIOR FACTORY APPROVAL ON RETURNS, AND APPROVALS ARE ISSUED ONLY TO BOLENS DEALERS OR DISTRIBUTORS.

TABLE OF CONTENTS

	Page		Page
General Safety Precautions	2	Preventive Maintenance	9
Engine Cautions	3	Adjustments	10
Serial Number	4	Lubrication	12
Specifications	4	Lubrication Chart	13
Controls	5	Maintenance Guide	13
Pre-Operational Checks	6	Minor Trouble Shooting	
Break-In Period	6	Guide	15
Starting the Engine	6	Wiring Diagram	15
Stopping the Engine	7	Optional Equipment	16
Operation	7	Power Take-Off (P.T.O.)	17
Run-In Period	9	Storing Your Husky Tractor	18

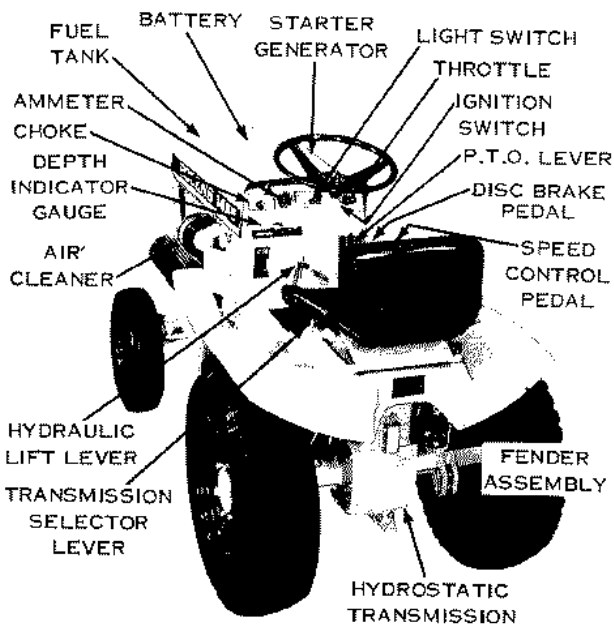

Figure 1

SERIAL NUMBER

To ensure prompt service when repairs or adjustments are required, your Bolens Dealer must have the following information:

1. Model number of unit.
2. Serial number of unit.
3. Model number of engine.
4. Serial and Spec. number of engine.

Your Bolens dealer has available a master Parts List for your unit. He can identify any parts you may require and furnish genuine factory replacements.

When ordering engine component parts, consult the Engine Manufacturer's Manual.

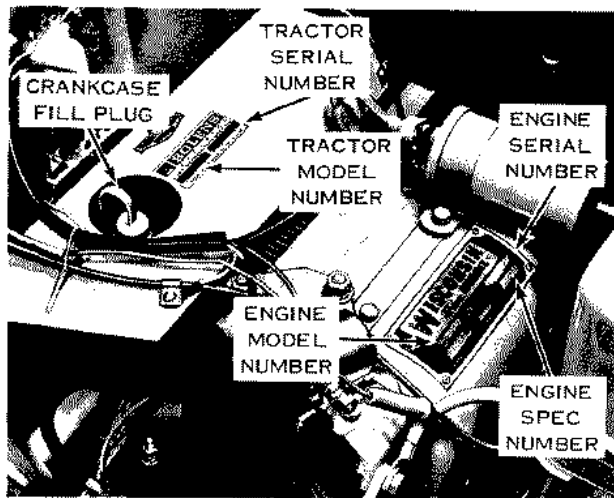

Figure 2

For your own personal reference, fill in the spaces provided below.

Model Number of Unit _____
 Serial Number of Unit _____
 Engine Model Number _____
 Engine Serial Number _____
 Engine Spec. Number _____

SPECIFICATIONS

(Specifications subject to change without notice)

NOTE

BOLENS RESERVES THE RIGHT TO MAKE CHANGES OR IMPROVEMENTS TO ITS PRODUCTS WITHOUT OBLIGATION TO INSTALL SAME ON PRODUCTS PREVIOUSLY MANUFACTURED.

Engine 33.1 cu. inch Wisconsin
 Type 4 cycle, single cylinder, air cooled
 Fuel capacity 5.3 gallons
 Engine oil capacity 2 quarts
 Transmission oil capacity 10 quarts
 Air cleaner Dry type
 Drive Hydrostatic transmission
 Speed. Infinitely
 variable. Forward: approx. 0-8 mph
 Reverse: approx. 0-4 mph
 Power to attachments . . . Triple belt drive (P.T.O.),
 with universal joints and
 splined shaft.
 Tires . . . Front: 5.70/5.00-8 (See Option Page 14)
 Rear: See optional equipment section,
 page 14.
 Height 45 inches
 Width 38 inches
 Length 72 inches
 Wheelbase 49 inches
 Turning radius 54 inches
 Ground clearance 8-1/2 inches
 Shipping weight 975 lbs.

Standard

equipment. . . P.T.O., splined shaft to drive front, center or rear attachments, hydraulic lift system with visual depth gauging, electric starting, head lights and tail lights, full fenders, adjustable all-angle seat-spring suspension with foam padded adjustable seat (easily removable for weather protection), 45 amp battery, selector lever for drive-neutral-park. Interlock switches to prevent tractor from being started with P.T.O. lever in DRIVE position. Tapered roller bearing front wheels and replaceable spindle bushings, automotive type muffler, compression release for easy starting, solid state ignition, three-unit regulator (automotive type), ammeter, extra-heavy channel frame, tilting hood for access to engine.

Location of tractor model and serial number Top left side of heat shield
 Location of engine model and serial number Front of engine cowling



Figure 3. Loose Parts

CONTROLS

Before operating the tractor, the operator should become familiar with the function and location of each control to ensure proper and efficient operation.

The following listed numbers and accompanying information correspond to those numbers assigned to the controls indicated in Figure 4.

1. Choke. Pull choke knob out to operate choke.
2. Ammeter. Indicates level of charge or discharge to or from battery.
3. Light Switch. Pull light switch knob out to turn on lights . . . push in to turn lights off.

NOTE

Ignition-starter switch (4) must be ON to turn on head and tail lights.

4. Ignition-Starter Switch. Turn ignition key to the right to start engine. Release when engine starts.

NOTE

DO NOT ACTUATE STARTER MORE THAN 30 SECONDS AT ONE TIME. LET STARTER COOL FOR TWO MINUTES.

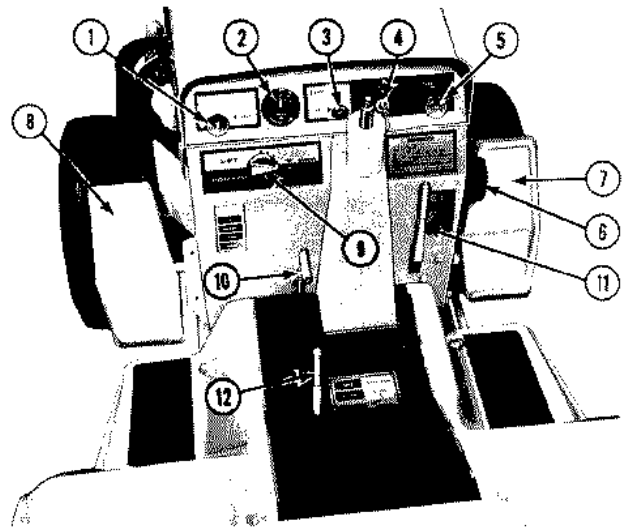

Figure 4

5. Throttle. Pull throttle knob out one-half way for starting. More or less throttle may be required due to grade of fuel and temperature variations. Allow engine to warm up, then adjust throttle to full engine RPM while operating under load.

6. Foot Brake. Use when vehicle is being towed or free-wheeling; when moving transmission selector lever (12) from NEUTRAL or PARK position to DRIVE position.

7. Travel Pedal. Depress with toe of foot for forward motion. Depress with heel of foot for reverse motion. Provides instant braking and speed regulation. (See Figure 6.)

8. Foot Rest.

9. Depth Indicator Gauge. Allows operator to locate original height or depth of attached implement. (See Figure 9.)

10. Hydraulic Lift Lever. Push lever up to raise and pull lever down to lower attachments. Push lift lever all the way down into lock for FLOAT position.

11. Power Take-Off (P.T.O.) Lever. Engages and disengages power to attached implements. Lever positions indicated on decal.

12. Transmission Lever. Place transmission selector lever in . . .

- NEUTRAL for towing. Do not tow over 5 mph
- DRIVE for infinitely variable speeds from approximately 0-8 mph forward to 0-4 mph in reverse.
- PARK for starting and when tractor is at rest.

CAUTION

DO NOT PLACE TRANSMISSION LEVER INTO PARK POSITION WHILE TRACTOR IS IN MOTION. SHIFTING INTO PARK MAY RESULT IN SERIOUS DAMAGE TO THE HYDROSTATIC TRANSMISSION.

PRE-OPERATIONAL CHECKS

The operator should become familiar with the following pre-operational check list prior to starting or operating the HUSKY.

1. Thoroughly clean area around crankcase oil dipstick, and check for proper level of engine oil. See Engine Manufacturer's Manual.
2. Check battery for proper water level.
3. Check gasoline tank for sufficient gas supply.
4. Check that air cleaner is free of debris. Check and clean regularly. Replace if necessary.
5. Clean flywheel screen. Use a brush similar to a wire brush or an automotive snow brush. Check and clean regularly. Clean engine fins at same time with an air hose. Clean screen from R.H. side of tractor. Clean as far as you can reach, turn engine over until part of screen which is not cleaned is exposed and finish cleaning. See Figure 14. Remove spark plug wire to avoid accidental starts.
6. Visually check for loose or missing nuts, screws, and damaged parts.
7. Check for even tire inflation. TIRE INFLATION SHOULD NOT BE LESS THAN 8 LBS. NOR MORE THAN 12.
8. Thoroughly clean area around hydrostatic transmission fill plug area, and check for proper level of transmission fluid. Check that transmission lever is in PARK. Start engine and allow it to idle while checking transmission fluid level.
9. Do not allow ignition switch to remain in the ON position when engine is not running. Remove key.
10. Check fuel petcock to be sure it is fully open.

BREAK-IN PERIOD

As with a new car, your new HUSKY Tractor should receive special attention. During the first few hours of operation, it is best to vary the engine speed (see inside front cover of engine manual) . . . avoid full-throttle driving . . . and avoid quick starts and stops until you have become well acquainted with your tractor. **IMPORTANT: THE TRACTOR IS SHIPPED FROM THE FACTORY WITH OIL IN THE ENGINE CRANKCASE. CHECK THE CRANKCASE AND THE HYDROSTATIC TRANSMISSION OIL RESERVOIR FOR PROPER OIL LEVEL BEFORE ATTEMPTING TO START YOUR UNIT. BECOME FAMILIAR WITH THE LOCATION OF EACH CONTROL. THIS TRACTOR IS EQUIPPED WITH INTERLOCK SWITCHES. THE ENGINE WILL START ONLY WHEN P.T.O. CONTROL LEVER IS IN "OFF" POSITION AND TRANSMISSION LEVER IS IN "PARK" OR "NEUTRAL" POSITION.**

Both the tractor and engine have been fully tested by the factory and your dealer to assure your complete

satisfaction. Keep this manual available at all times, read it carefully, if you have any questions that are not answered in the manual, consult your B-Iens dealer.

STARTING THE ENGINE

ELECTRIC STARTING

1. THE ENGINE WILL START ONLY WHEN P.T.O. CONTROL LEVER IS IN "OFF" POSITION AND TRANSMISSION LEVER IS IN "PARK" OR "NEUTRAL" POSITION.
2. Pull out choke. Experience will indicate need for more or less choking due to temperature variations, grade of fuel, engine heat, etc.
3. Pull out throttle one-half way. More or less throttle may be required due to grade of fuel and temperature variations.
4. Turn ignition key to the right to start engine. Release key when engine starts.
5. Allow engine to warm up. Move choke slowly forward; pull out throttle and lock at full speed while operating.
6. To stop the engine, bring engine back to idle, place transmission lever in PARK and P.T.O. lever in "OFF" position and turn ignition switch off. Remove the ignition key when the tractor is not in use, or left unattended. If engine has been working hard let it idle several minutes before shutting it off for storage of tractor.

EMERGENCY STARTING

In case of an electrical failure, proceed as follows: (See first paragraph under electric starting.)

1. Recharge or replace battery.
2. 12 Volt Jumper cables may be used. NOTE: If jumper cables are used, cables must be connected, Positive (+) to Positive (+) and Negative (-) to Negative (-).
3. After engine has started, allow it to warm up. Move choke knob slowly forward, pull out throttle and lock at full speed.
4. Remove tractor battery and have it fully charged as soon as possible.
5. After the battery is fully recharged and has been checked, reinstall it in the tractor, being careful to connect ground cable last.
6. Check generator belt for proper tension. Belt should depress 1/4 inch between pulleys with normal thumb pressure as shown in Figure 5. Should adjustment be required, shut engine off, loosen the 2 lower generator mounting screws "B" and generator ad-

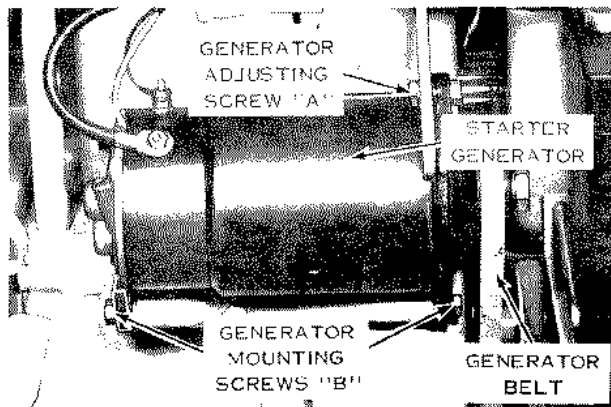

Figure 5

justing screw "A". Pivot generator outward from engine until proper tension is obtained.

NOTE

NEVER PRY OUT GENERATOR WITH A LONG HEAVY BAR OR TOOL AS THIS COULD RESULT IN PREMATURE BEARING FAILURE.

7. Tighten the generator adjusting screw "A" and generator mounting screws "B". Make sure all bolts are securely tightened.

STOPPING THE ENGINE

1. If the engine has been operating under a heavy load and is hot, do not stop engine suddenly. Allow it to idle for approximately three to five minutes.

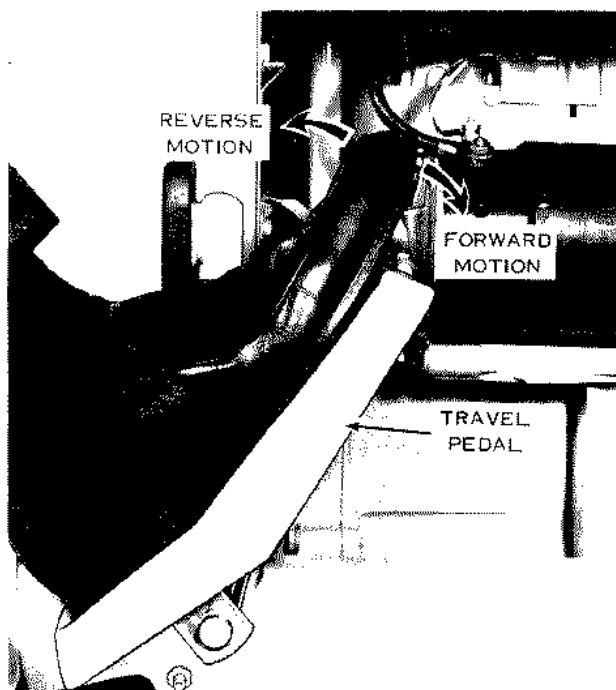

Figure 6

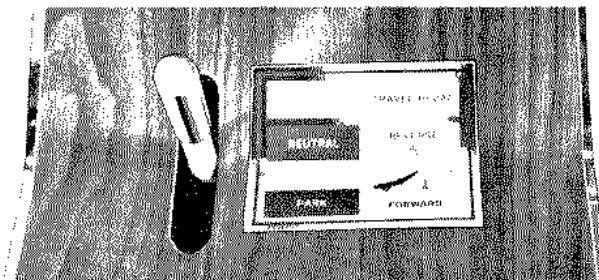

Figure 7

This will reduce the engine temperature more quickly and evenly than stopping the engine.

2. Turn ignition switch off, put transmission lever in "PARK" position, P.T.O. lever in "OFF" position and remove ignition key.

OPERATION

BEFORE DRIVING THE HUSKY, THE OPERATOR SHOULD BE FAMILIAR WITH THE LOCATION AND FUNCTIONS OF ALL CONTROLS. THE ENGINE WILL START ONLY WHEN P.T.O. LEVER IS IN OFF POSITION AND TRANSMISSION LEVER IN PARK OR NEUTRAL.

Placing the transmission lever in PARK or NEUTRAL position locks the travel pedal in its centered or neutral position, to prevent use of the travel pedal when selector lever is in PARK or NEUTRAL.

Depress foot brake (Figure 4, Reference 6) and place transmission lever in DRIVE position. ALWAYS DEPRESS FOOT BRAKE PEDAL BEFORE MOVING TRANSMISSION LEVER INTO "NEUTRAL", "PARK" OR "DRIVE" POSITION TO AVOID CREEPING.

Release brake pedal, and slowly apply pressure to the travel pedal with toe of right foot for forward motion, or if reverse motion is desired, slowly apply pressure to travel pedal with heel of right foot. (See Figure 6.)

The hydraulic lift lever can be maneuvered while vehicle is at rest or in motion. Lift lever to raise and push down on lever to lower attachments. When the lever is released, it will automatically return to NEUTRAL position and hold, except when in the FLOAT position. Push lift lever all the way down to lock in FLOAT position. The FLOAT position must be used when the operator wants the attached implement to follow ground contours independently. (See Figure 8.) Consult your attachment manual for correct lift lever position.

CAUTION

Be sure attachment is completely hooked up before using hydraulic lift. Damage could result. Move the attachment through its complete range slowly to make sure it does not bind or have interference. Make necessary adjustment if required.

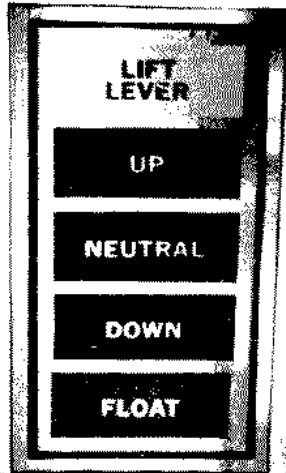

Figure 8

NOTE

The hydraulic lift lever, except when placed in FLOAT position, should always return to the NEUTRAL position after raising or lowering operations.

Located on the instrument panel is a depth indicator gauge which is used in conjunction with the lift lever. Lower the attached implement to its desired height or depth, and manually turn the indicator gauge to the ground level position indicated in Figure 9. Thus this gauge allows the operator to raise the attachment for maneuvering and assure him of returning attachment to the same height or level he was operating it at. By visually observing the depth indicator when lowering an attachment, the lift lever can be released when indicator reaches the original desired or ground level setting. **NOTE:** Study each attachment owner manual for additional information on **DEPTH GAUGE INDICATOR**.

The P.T.O. and hydrostatic transmission are separate systems, therefore, the P.T.O. can be engaged or disengaged as desired by the operator. **IMPORTANT: DO NOT ENGAGE P.T.O. WITHOUT AN IMPLEMENT ATTACHED. ALWAYS REMOVE**

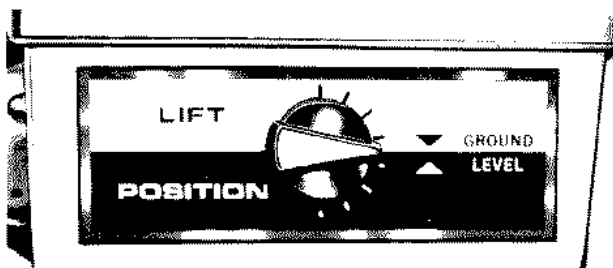

Figure 9

JOINTS FROM P.T.O. SHAFT AFTER ATTACHMENT IS REMOVED. SERIOUS DAMAGE WILL RESULT IF JOINTS ARE LEFT ON.

The hydrostatic transmission gives the operator a choice of infinitely variable speeds from 0 to 8 mph forward, and 0 to 4 mph in reverse. Avoid excessive **HIGH** travel speed whenever possible. High travel speeds are most practical for transport or pulling light attachments. Lower travel speeds are best for most jobs such as snow casting or mowing.

When using attachments, it is required that the tractor operate at **FULL THROTTLE**. While operating under heavy load conditions, listen to the engine RPM. If the engine begins to labor, do not advance the travel pedal. By letting up on the travel pedal, the ground speed will decrease and the engine speed will increase, thereby, allowing engine to maintain constant P.T.O. speed. (See Figure 10.)

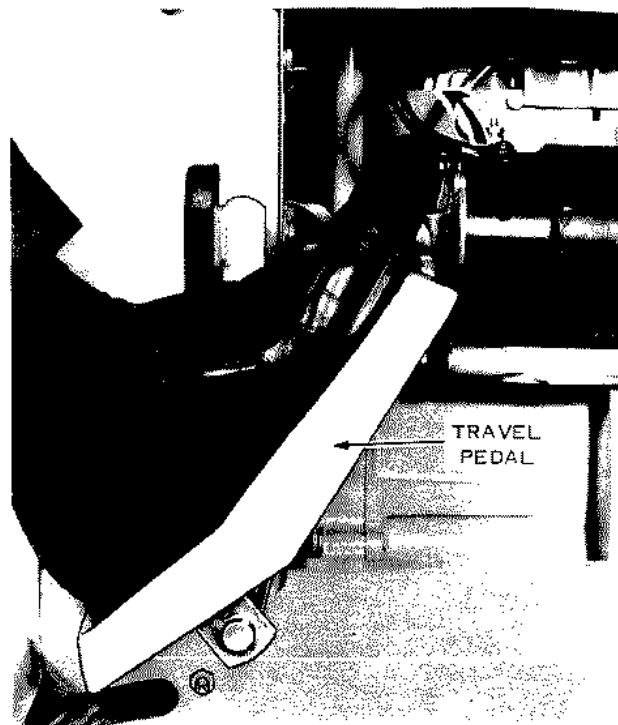

Figure 10

The travel (control) pedal is generally used for dynamic braking. To slow down or stop the tractor while it is in forward motion, gradually apply pressure to the travel control pedal with heel of right foot until tractor comes to a full stop. To slow down or stop the tractor while it is in reverse motion, apply pressure to travel control pedal with toe of right foot until tractor comes to a full stop.

CAUTION

DO NOT ATTEMPT TO PLACE TRANSMISSION LEVER IN PARK POSITION UNTIL

TRACTOR HAS COME TO A FULL STOP. MECHANICAL DAMAGE CAN RESULT.

SHOULD ENGINE STALL WHEN SHIFT LEVER IS IN DRIVE, TRAVEL PEDAL MUST BE BROUGHT BACK TO NEUTRAL POSITION TO SHIFT LEVER INTO NEUTRAL, OR PARK, TO RESTART MOTOR.

When towing the tractor, place the transmission lever in NEUTRAL position only. DO NOT EXCEED SPEED OF 5 MPH WHILE TOWING. Use foot brake pedal to stop vehicle when towing.

RUN-IN PERIOD

BEFORE OPERATING THE TRACTOR AT FULL LOAD, IT SHOULD BE OPERATED AT ONE-HALF THROTTLE FOR APPROXIMATELY ONE-HALF HOUR WITH NO LOAD APPLIED. AFTER THE FIRST HALF-HOUR OF OPERATION, RUN THE TRACTOR AT FULL THROTTLE WITH NO LOAD APPLIED FOR AN ADDITIONAL TWO HOURS.

ATTACH A LIGHT LOAD TO THE TRACTOR. OPERATE THE TRACTOR WITH LIGHT LOAD FOR A PERIOD OF APPROXIMATELY FIVE HOURS AT FULL THROTTLE. THE TRACTOR IS NOW READY FOR NORMAL LOAD OPERATION.

NOTE

ALWAYS OPERATE THE ENGINE AT FULL THROTTLE FOR BEST ATTACHMENT PERFORMANCE. CONSULT YOUR ATTACHMENT MANUALS FOR SPECIFIC INSTRUCTIONS.

PREVENTIVE MAINTENANCE

A little time spent each day by the operator on preventative maintenance will lead to longer operating life of the HUSKY.

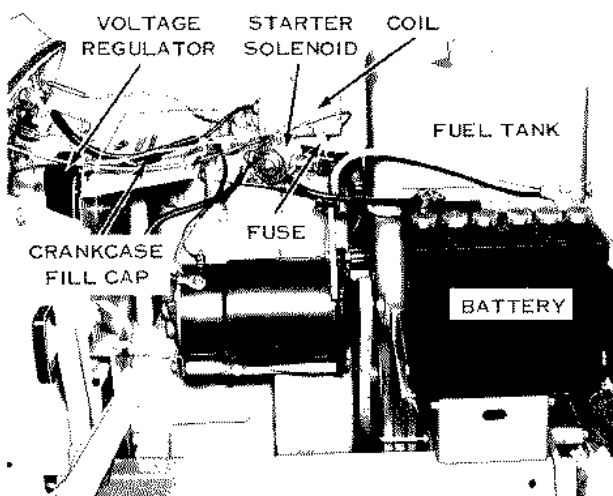

Figure 11

The removal of debris, dirt and grease accumulations are considered normal maintenance practices and can help discover minor difficulties before they become troublesome.

ENGINE - Remove ignition key. Remove all dirt from around engine fins with an air hose and fly wheel screen, base of spark plug and crankcase oil dipstick. A gap of .030 inch should be maintained between spark plug electrodes. See Engine Manufacturer's Manual for further maintenance of engine.

HYDROSTATIC TRANSMISSION - Remove ignition key. Remove all dirt from around transmission filler plug area and filter. Clean transmission cooling fins periodically with an air hose. If tractor is operated in a dusty environment, check and clean cooling fins more frequently. Consult your Bolens dealer for transmission maintenance. (See Figures 12 and 13.)

ENGINE COOLING SCREEN - Check and clean engine air cooling screen. Use a narrow wire brush or a brush similar to an automotive snow brush. See Figure 14.

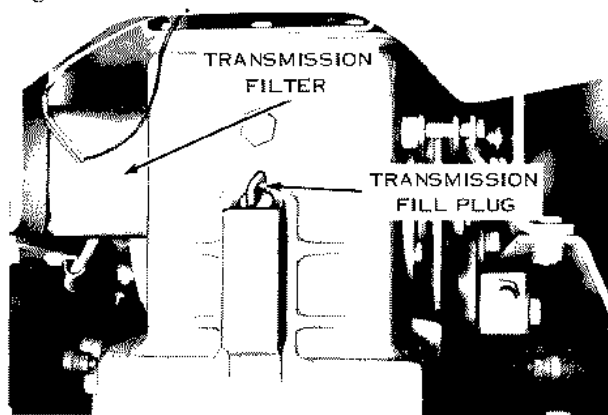

Figure 12

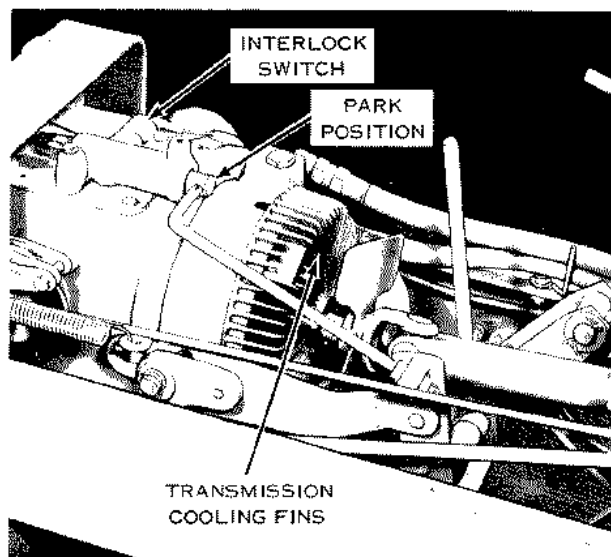

Figure 13

CAUTION

The flywheel screen is convex (Curved Outward), do not use undue pressure when cleaning this screen as this screen can be pushed inward, thereby lowering its efficiency.

NOTE

It is necessary that this engine cooling screen is cleaned at regular intervals. Under extreme conditions this screen should be cleaned several times during a mowing or similar operation. Failure to do this will cause an extreme temperature build-up in the engine.

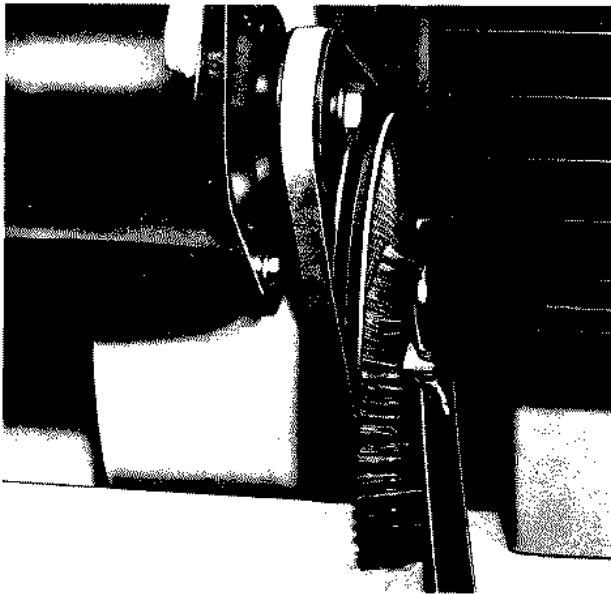

Figure 14

FRONT WHEEL BEARINGS -

1. Remove hub cap.
2. Remove cotter pin and unscrew slotted nut.
3. Remove bearing.
4. Pack bearings with the lubricant called out in the Lubrication Section of this manual.
5. Install bearing.
6. Turn slotted nut on spindle hand-tight, test-spin wheel to align bearings, then back nut off to nearest slot in line with hole in spindle, and install a new cotter pin.
7. Insert new cotter pin and press on hub cap.

FUEL TANK - Fill with clean fresh gasoline of regular grade. (For cold weather operation use winter blend gasoline.) **DO NOT MIX OIL WITH GASOLINE. REFUEL OUTDOORS WITH ENGINE STOPPED AND COOL.**

Check to see that vent hole in fuel tank cap is not plugged.

GENERATOR - Keep terminals tight and clean. Check belt for wear. Adjust tension or replace belt if badly worn.

AIR CLEANER - See Engine Manufacturer's Manual and decal "VERY IMPORTANT" on air cleaner. See Figure 15.

BATTERY - Keep cables and terminals clean and apply a light coat of vasoline or oil for protection. Check battery bracket for corrosion and keep clean. Do not over-tighten battery mounting. Reinstall in same position. **IMPORTANT:** When servicing the battery, be sure battery cables are disconnected before attempting removal of the battery from the tractor. **ALWAYS DISCONNECT GROUND (-) CABLE FIRST.** When installing the battery, always check the polarity of the battery terminals to be sure the battery is not reversed. The negative terminal (-) is ground. Apply a light coat of vasoline or oil to the inside of the clamp terminals and over the bolt stud before connecting terminals. **ALWAYS CONNECT THE GROUND TERMINAL (-) LAST.** Should it become necessary to remove the battery, when reinstalling it; 1.) Place hold down rods in place. 2.) Tighten wing-nuts (**FINGER TIGHT ONLY**) to avoid possible damage to battery case.

VOLTAGE REGULATOR - Keep terminal connections tight and clean. Consult your dealer for servicing adjustments or repairs.

STARTER SOLENOID - Keep terminal connections tight and clean.

PNEUMATIC TIRES - Keep both front and rear tires inflated evenly. Under no circumstances should tire inflation be less than 8 pounds pressure nor more than 12 pounds. Check air pressure regularly with a low pressure gauge. Over or under inflation will result in premature tire failures.

ADJUSTMENTS

For adjustments not discussed in this manual, consult your Bolens dealer.

STEERING ADJUSTMENT (See Figure 15.)

1. Turn steering wheel so that front wheels are straight ahead.
2. Disconnect R.H. side of tie rod from steering arm. Measure distance across front of tire, center line to center line. Measure distance across rear of front tire, center line to center line and adjust toe in to 3/8" maximum by turning tie rod in or out as required. (Reading should be 3/8" less when measured across front of the two tire center lines.)
3. Tighten hex nut securely, and reinstall tie rod into steering arm making sure lockwasher is between ball joint and arm.
4. Check length of steering drag link. Over all length should be approximately 24-9/16 inches. Adjust if necessary.

NOTE

If a front tire interferes with front mounted attachment brackets or center mounted attachments in short turns, correct as follows:

5. At the rear of the steering drag link where it connects to the steering gear on the right hand side of

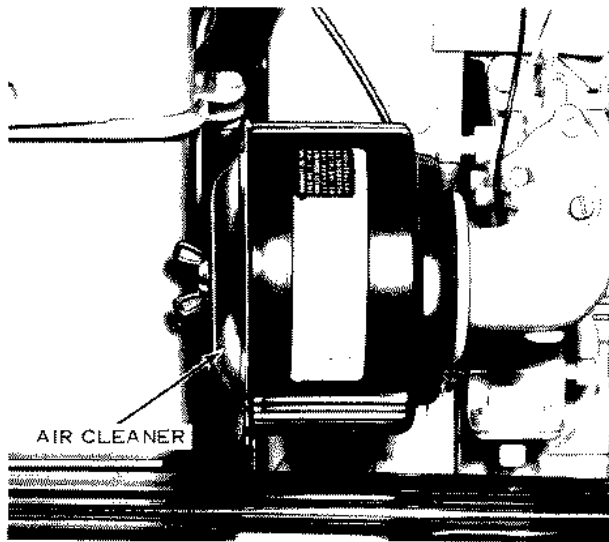

Figure 15

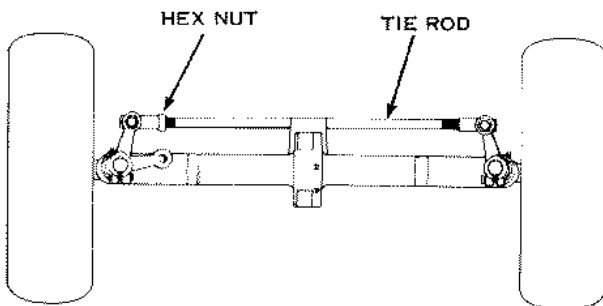

Figure 16

tractor, you will find a slot in the frame. See Figure 17.

a. At each end of the slot there is a square head setscrew, with a lock nut, inserted into the frame.

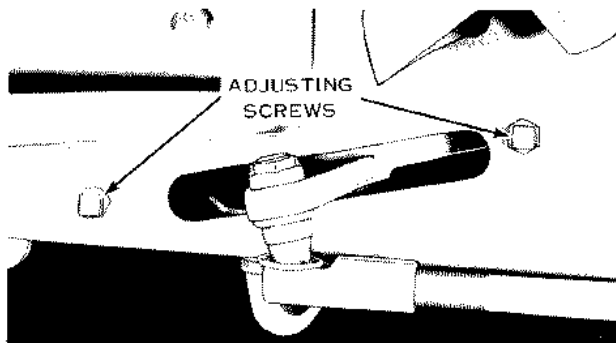

Figure 17

6. Turning these screws in will restrict the turning radius.

a. The screw at the front of the slot area controls the Left turning radius.

b. The screw at the rear of the slot controls the Right turning radius.

7. Adjust as required to eliminate interference. Tractor turning radius should be approximately the same left and right.

POWER TAKE-OFF (P.T.O.) LEVER (See Figure 18.)

1. Place P.T.O. lever in the OFF position.

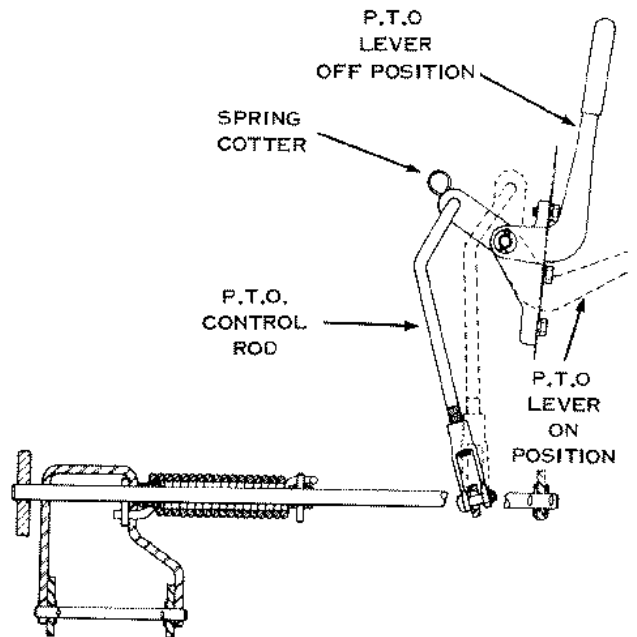

Figure 18

2. Remove spring cotter pin and turn the P.T.O. control rod in until the desired tension is obtained, or the "over-the-center" snap is felt when moving the P.T.O. lever from OFF position to ON position. Reinstall spring cotter pin.

3. With the P.T.O. lever still in the ON position, loosen the hex capscrew which secures the upper belt guide shown in Figure 19. Adjust upper belt guide for a 1/8 to 1/4 inch clearance between belt and belt guide. Tighten hex capscrew securely.

P.T.O. BELT ADJUSTMENT (See Figure 19.)

Should it become necessary to replace P.T.O. belt, install new belt as follows:

1. Place P.T.O. lever in the OFF position.

2. DO NOT disturb upper belt guide, if 1/8 to 1/4 inch gap is evident with P.T.O. lever in the "ON" position.

3. Remove lower belt guide.

4. With hood open place the three NEW BELTS over both ENGINE and IDLER pulley with your right hand while feeding belts up from below with left hand, then feed into grooves of P.T.O. pulley.

5. Reinstall lower belt guide and adjust for a 3/32 to 1/8 inch clearance between belt guide and belts with P.T.O. lever in the "ON" position. Tighten the two hex capscrews securely. Check upper belt guide and adjust if necessary. Place P.T.O. lever in OFF position.

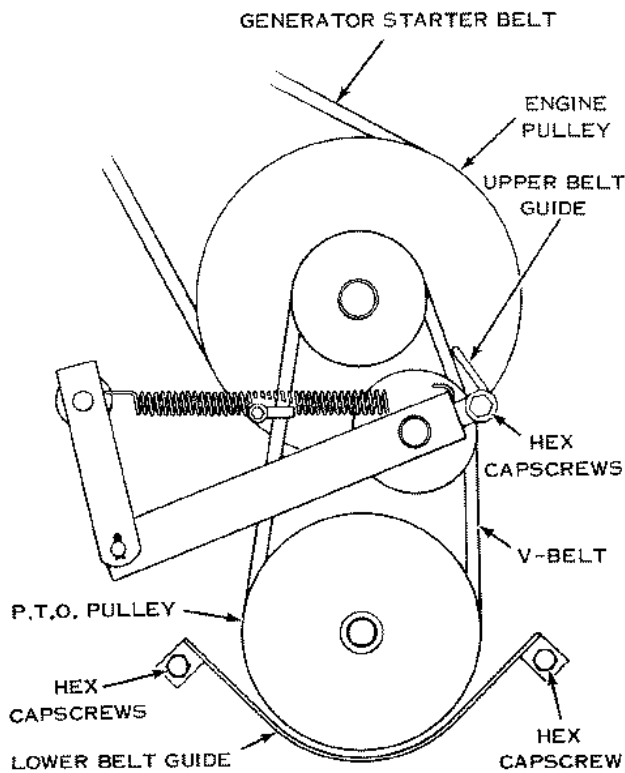

Figure 19

DISC BRAKE (See Figures 20 and 21.)

1. Remove cotter pin and clevis pin from brake rod assembly.
2. Hold brake pedal in its normal relaxed position. Turn end yoke until one inch maximum free brake-pedal travel is attained before pedal depression gives braking action.

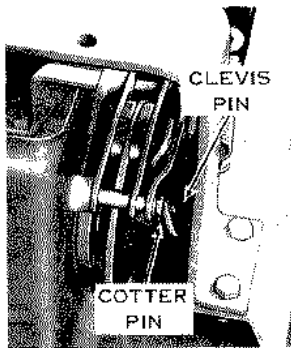

Figure 20

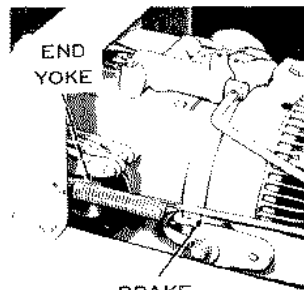

Figure 21

3. Reinstall clevis pin and secure with cotter pin.

NOTE

Before adjusting, inspect disc brake assembly to determine whether an adjustment is needed or if brake pad replacement is necessary. For disc brake service, consult your Bolens dealer.

SEAT ADJUSTMENT (4 positions available)

The 1455 tractor features adjustable seat spring suspension. Leaf springs can be added or removed from the seat as desired by the operator. If additional leaf springs are desired, order them through your Bolens dealer.

Seat Adjustment

1. Tilt seat forward.
2. Remove spring cotter pins shown in Figure 22.
3. Lift seat; using one of the two holes provided, position adjusting blocks as shown in Figure 21 for the front two seat positions. To move seat back, rotate adjusting blocks 180 degrees, and use either of the two sets of holes provided.
4. Reinstall spring cotter pins.

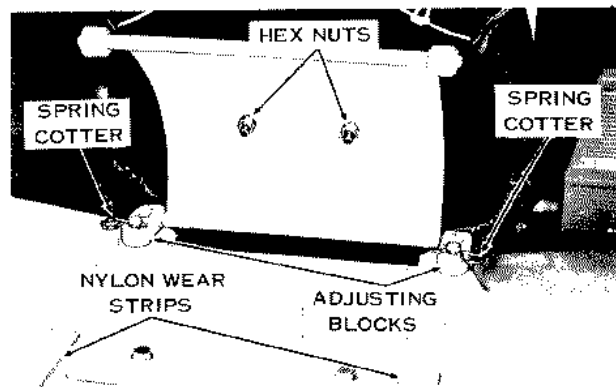

Figure 22

Leaf Spring Adjustment

1. Tilt seat forward, and brace to avoid it falling.
2. Remove the two hex nuts shown in Figure 22 then add or remove leaf springs as desired.
3. Reinstall hex nuts and tighten securely.

Seat Removal

To remove the seat, remove the two spring cotter pins shown in Figure 22, and lift seat from tractor.

LUBRICATION

Proper lubrication and regular maintenance will increase the operating life of your HUSKY and attachments. Negligence on the part of the operator in regard to regular lubrication or general maintenance can depreciate the dependability of this vehicle and void warranty. It is suggested that lubrication recommendations in this manual be followed. A lubrication record prepared by the operator would be beneficial.

The numerically listed locations on the lubrication chart correspond to those numbers shown on Figures 23 and 24.

LUBRICATION CHART

LOCATION	TYPE OF LUBRICATION	AMOUNT OF LUBRICATION	FREQUENCY OF LUBRICATION
1. Wheel Bearings	Wheel Bearing Grease	Pack	Once a year
2. Front Wheel Spindles	Gun Grease	As Req'd.	8 hrs.
3. Front Axle Pivot	Gun Grease	As Req'd.	8 hrs.
4. P.T.O. Housing	Gun Grease	As Req'd.	8 hrs.
5. Air Cleaner	See Engine Manufacturer's Manual & Decal on Cleaner		
6. Engine Oil Drain Plug	Located on left hand side of lower engine block		
*7. Disc Brake Linkage	Oil	Coat surfaces	25 hrs.
●*8. Hydrostatic Transmission	Automatic Transmission Fluid - Type A	Add to plug level	Check once a week or 25 hrs.
9. Transmission Filter			Change every 300 hrs. or with oil change
10. Hood Hinge	Oil	Coat surfaces	25 hrs.
11. Generator-Starter	No lubrication required		
*12. Universal Joints	Gun Grease	One stroke of grease gun	△
13. Pivot Shaft (2 Fittings)	Gun Grease	One stroke of grease gun	8 hrs.
*14. Travel Pedal Pivot Shaft & Bearings	Oil	Coat surfaces	25 hrs.
*15. Engine Crankcase	See Engine Manufacturer's Manual		
<p>● Capacity 10 quarts. See your dealer for specified oil for complete refills. * More frequent if application demands. △ Grease every 250 hours or once each year, whichever occurs first. NOTE: For best access to grease fitting on front universal, place transmission lever in neutral and rotate driveshaft until opening with grease fitting faces the left side of tractor. With the grease gun and hose assembly specified below the nozzle will just fit through the opening and onto the grease fitting. A small amount of extra hand pressure might be needed to press nozzle onto fitting. NOTE: A hand type grease gun with a flexible hose is recommended when greasing your unit. This type grease gun can be purchased at most automotive supply stores. Ask for Alemite All Purpose Grease Gun No. 4031 with Flexible Hose Assembly No. 6703A, or similar type. <u>Hi-pressure type grease guns</u> could cause damage to the fittings and bearing seals. Lubricate all linkages, levers and pins not equipped with grease fittings with an oil can once a week, or oftener depending on operating conditions.</p>			

MAINTENANCE GUIDE

	EVERY 10 HOURS OF OPERATION	EVERY 25 HOURS OF OPERATION	EVERY 50 HOURS OF OPERATION
Check battery	X*	If tractor is stored, battery charge should be checked every 60 days	
Check air in tires (8 to 12 lbs.)		X*	
Check engine crankcase oil	See Engine Manufacturer's Manual		
Drain engine crankcase oil (left side of engine)			X*
Check transmission oil (add to filler plug level as needed)		X*	
Check and clean cooling air screen (see Figure 14)	X*		
Lubrication points (see Lubrication Chart)	X*		
Check generator-starter mounting bolts		X	
Check for belt wear			X
Check and clean cooling fins of transmission	X*		
* Varies depending on operating conditions, climate, etc.			

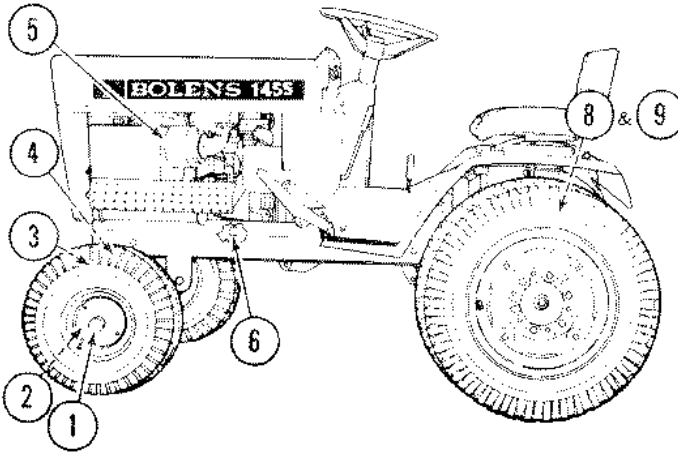
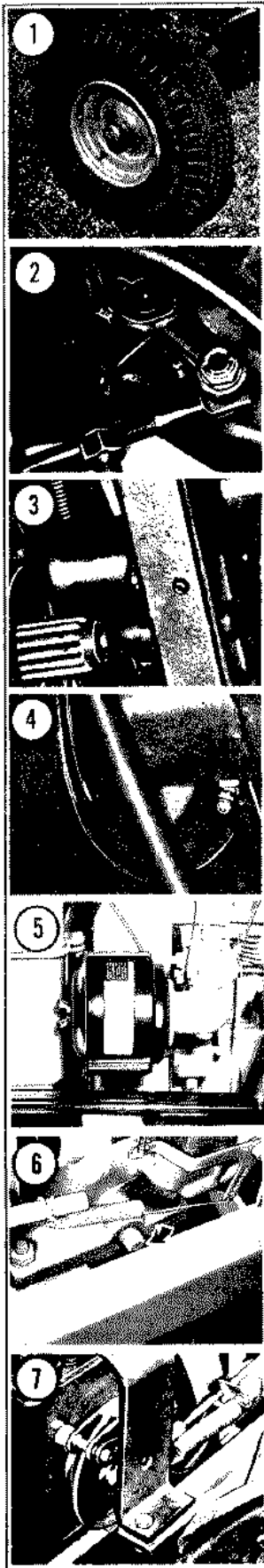

Figure 23

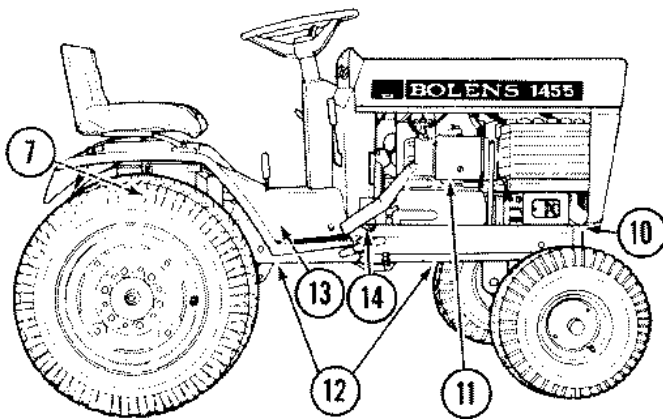
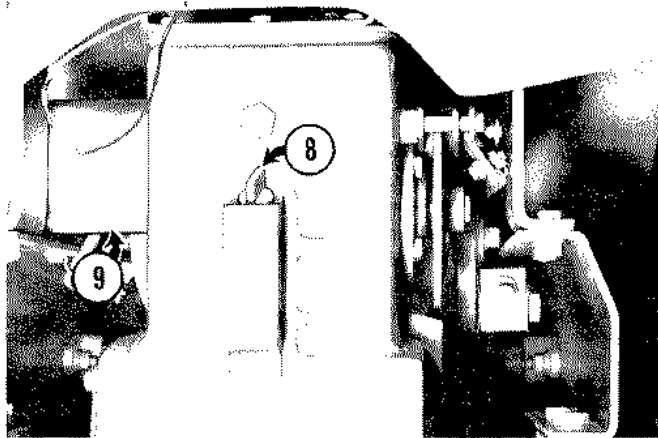
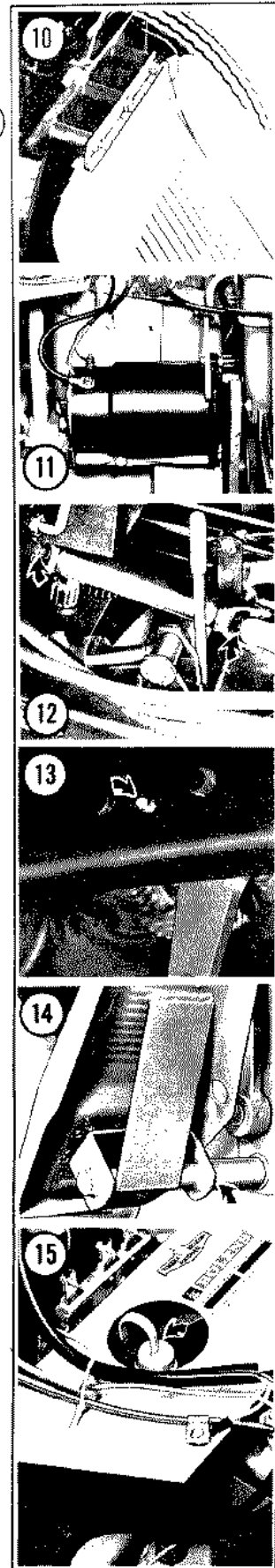

Figure 24



MINOR TROUBLE SHOOTING GUIDE

IF TRACTOR ACTS IN FOLLOWING MANNER:	CHECK FOR POSSIBLE CAUSE													
	CLEAN OFF ENGINE FINS	FLYWHEEL SCREEN (CLEAN)	FAULTY IGNITION*	FAULTY SPARK PLUG	EMPTY FUEL TANK	BATTERY	CARBURETOR	OIL	AIR CLEANER (CLEAN)	CHOKE	SEE YOUR BOLENS DEALER	CONTROLS ADJUSTED INCORRECT	CONTROLS NOT IN CORRECT POSITION	CHECK INTERLOCK SWITCHES
Engine will turn over but won't start			X	X	X		X			X	X			
Engine will not turn over						X					X		X	X
Starts only after repeated tries			X	X			X			X	X			
Stalls in a few seconds					X		X				X			
Stalls when hot	X	X	X	X	X		X	X	X		X			
Idles rough			X				X			X	X			
Engine overheats	X	X	X				X	X	X		X			
Can not put transmission control in neutral or park											X	X	X	

* See Engine Manual or your Bolens Dealer.

WIRING DIAGRAM

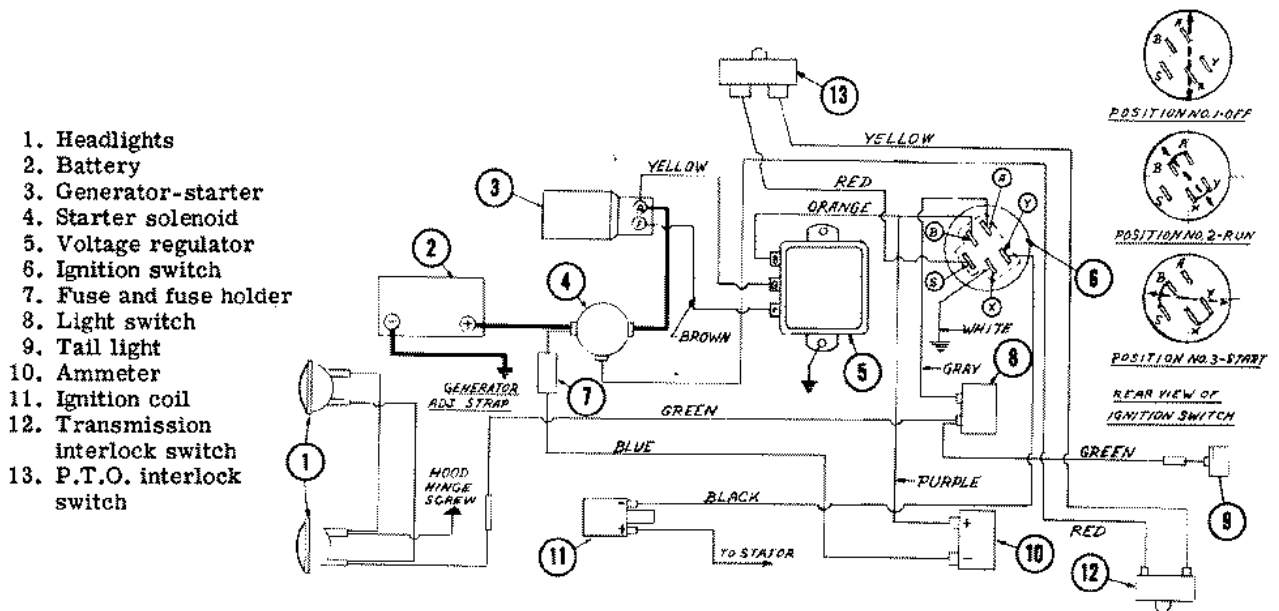

BEFORE WORKING ON WIRING ALWAYS DISCONNECT BATTERY CABLES, FIRST GROUND (-) CABLE, THEN POSITIVE (+) CABLE.

WHEN WORK IS DONE, CONNECT POSITIVE CABLE FIRST, GROUND CABLE LAST.

Figure 25

OPTIONAL EQUIPMENT

REAR TIRES

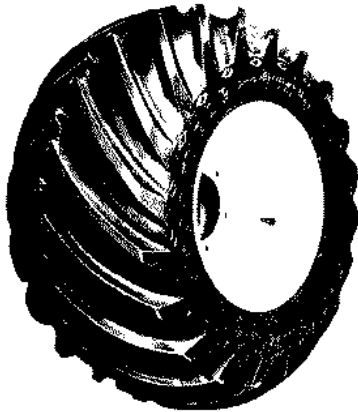

TERRA TIRE KIT (26 x 12.00-12)
MODEL NO. 18017-01
Figure 26

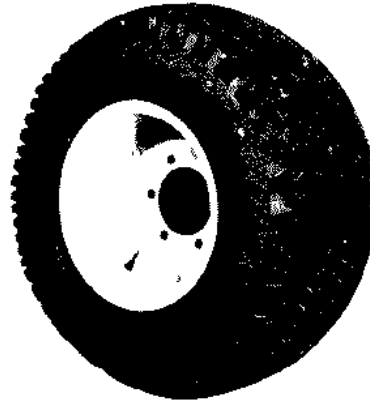

LAWN & GARDEN TERRA TIRE KIT
(26 x 12.00-12)
MODEL NO. 18016-01
Figure 27

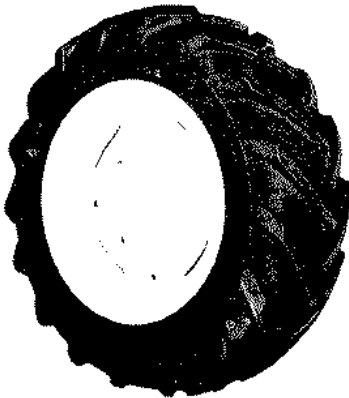

STANDARD AGRICULTURAL TIRE
KIT (27 x 8.50-15)
MODEL NO. 18019-01
Figure 28

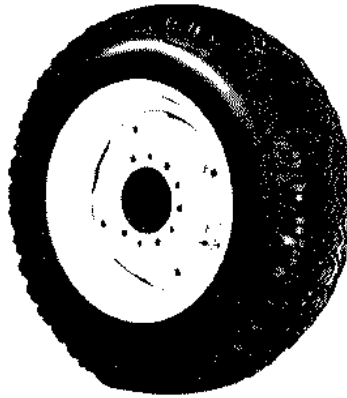

STANDARD LAWN & GARDEN TIRE
KIT (27 x 8.50-15)
MODEL NO. 18018-01
Figure 29



DUAL WHEEL KIT (27 x 8.50-15)
MODEL NO. 18020-01
Figure 30

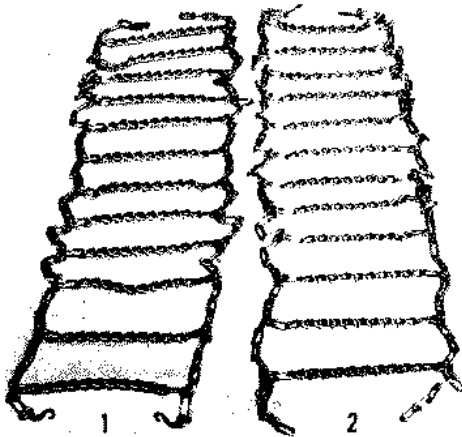

TIRE CHAINS

- (1) Model No. 19614-01 - For 26 x 12.00 - 12 Tire
 - (2) Model No. 19613-01 - For 27 x 8.50 - 15 Tire
- Figure 31

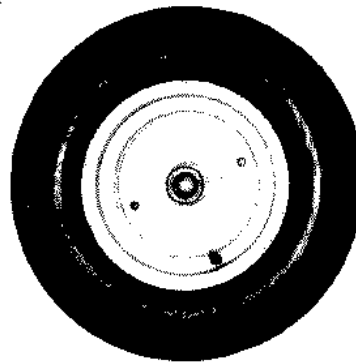

HIGH FLOTATION FRONT WHEEL KIT
(20 x 8.00-10 Tire)
MODEL NO. 18015-01
Figure 32

POWER TAKE-OFF (P.T.O.)

Drive shaft delivers power directly from power take-off (P.T.O.) to attachment--front, rear and center-mounted. Switching powered attachments requires only a short time. Slide universal joint over end of splined power take-off shaft liberally greasing shaft, align holes in joint and shaft, and secure with special cotter pin.

CAUTION

Do not neglect to install spring cotter into universal joint.

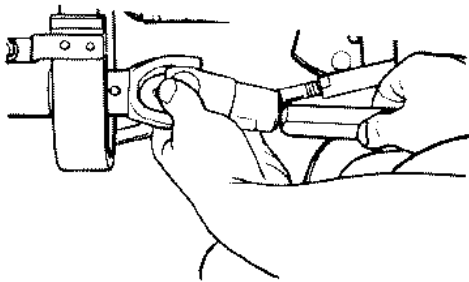

Figure 33

Slide attachment drive and P.T.O. drive shaft universal joint together; install pins into hitch points. The P.T.O. (power take-off) drive shaft is located under the front of the tractor frame and is connected to the engine by three drive belts. This assembly has a drive shaft which is splined at both ends so that front, center and rear power attachments can be coupled directly to it. Universal joints on the attachments are equipped with needle-bearings allowing you to raise or lower attachments (with hydraulic lift lever) while the tractor is under full power.

Your HUSKY Tractor has the fastest attachment switch system in the industry. No belts to install . . . no special tools needed.

CAUTION

ALWAYS REMOVE UNIVERSAL JOINT FROM POWER TAKE-OFF SHAFT WHEN ATTACHMENTS ARE REMOVED FROM TRACTOR. IF THE JOINT IS NOT REMOVED AND THE POWER TAKE-OFF IS ENGAGED, DAMAGE WILL RESULT FROM WHIPPING ACTION OF THE FREE JOINT, AND PERSONAL INJURY COULD OCCUR.

WHEEL WEIGHT KIT

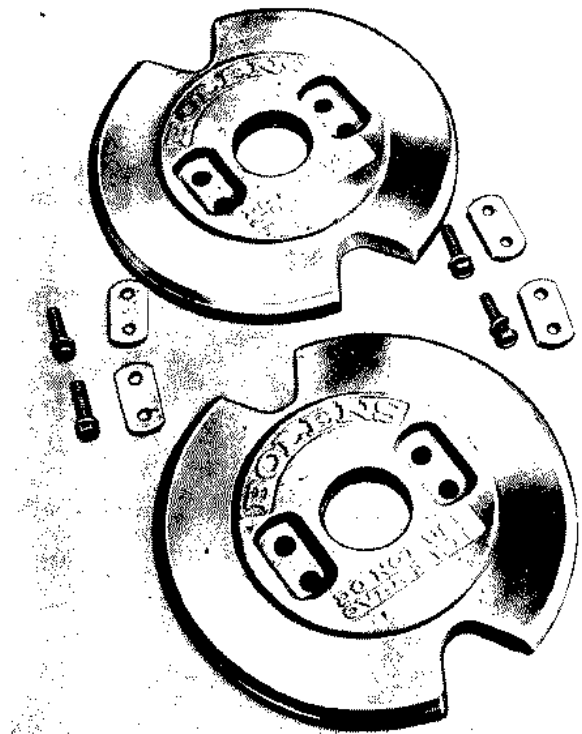

Figure 34

CAUTION

DO NOT INSTALL MORE THAN THREE WHEEL WEIGHTS TO ONE WHEEL. (SEE FIGURE 34.)

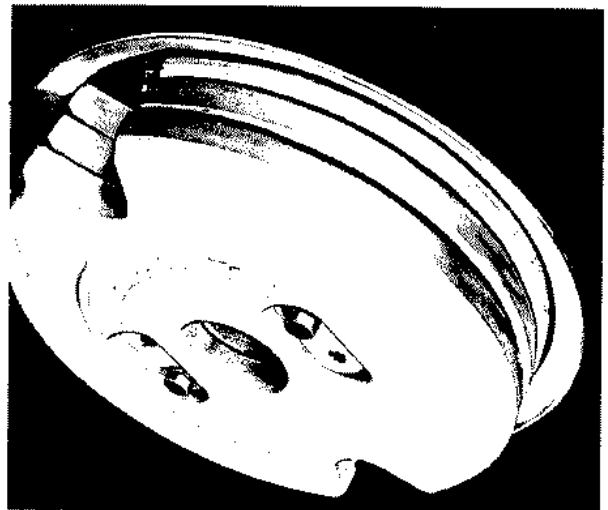

Figure 35

STORING YOUR HUSKY TRACTOR

Always keep your HUSKY tractor in a dry protected place when not in use to prolong its usefulness and appearance. With year around use, it is not necessary to "store" the tractor; but when it is not to be used for some time, it should be prepared for storage in the following manner:

1. Completely clean all accumulated dirt or trash from all parts, especially engine fins and flywheel screen.
2. Wipe oil or a rust preventative on any parts that may rust.
3. Drain gas tank and carburetor.
4. Remove spark plug and put a small amount of oil (SAE 30) in cylinder head. Consult Engine Manufacturer's Manual.
5. Without starting the tractor, turn the engine over a few times to fully lubricate the cylinder walls, valve seats and valve stems. This can be done by engaging the key starter briefly.
6. Keep tractor covered.
7. BATTERY - Each week fill each cell to triangle with distilled water. Keep terminal posts cleaned of corrosion salts and coat with petroleum jelly or grease. Keep cables clean. Stored battery must be fully charged and with all cells filled to triangle. Store at cool temperature 20° to 50°. Check each two months and charge as necessary.
8. The air cleaner should be cleaned and sealed off with a plastic bag or facsimile, for the duration of the storage period.
9. If tractor is stored with an attachment mounted on it, the attachment MUST be lowered to the ground, and P.T.O. lever put in OFF position.

LUBRICATION & MAINTENANCE RECORD

Date Performed	Description of Maintenance	Hours Run

Bolens reserves the right to change specifications, add improvements, or discontinue the manufacture of any of its equipment without notice or obligation to purchasers of its equipment when equipment was purchased prior to decision to make changes, add improvements, or discontinue manufacture.

Bolens approval of use of attachments manufactured by other manufacturers is limited to assurance that such use will not void Bolens warranty on the Bolens equipment to which the outside manufactured attachments is adapted. The responsibility for the design, performance, durability, safety in operation, service repair availability, and warranty obligation remain with the outside manufacturer. Bolens specifically excludes from its warranty obligation all such outside manufactured attachments.

Bolens warranty will be voided if unapproved attachments are adapted to use with Bolens equipment and are so used.



BOLENS

PORT WASHINGTON, WISCONSIN, U.S.A.

PRINTED IN U.S.A.